

User Manual

Profiler Revolution SAT Ref. 6702

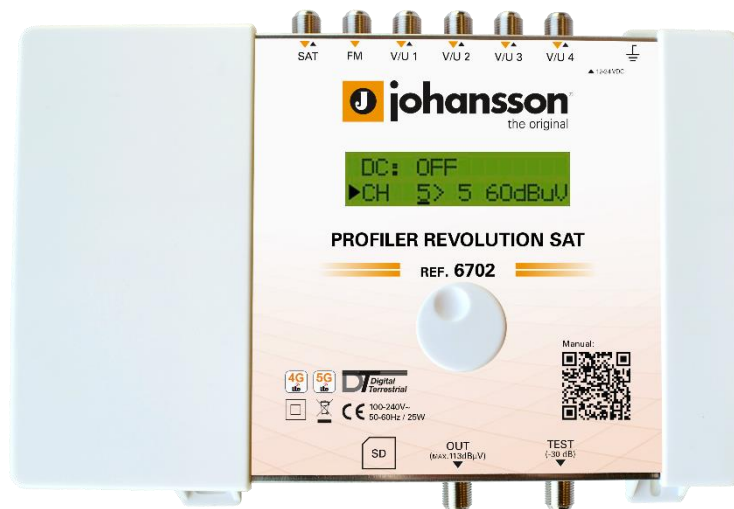

PATENT PENDING

SW Version 1.3.0

CONTENTS

1. INTRODUCTION	3
1.1. Product description	3
1.2. Typical installation	3
1.3. Package contents	3
1.4. Hardware installation	4
1.5. Mounting the Profiler Revolution SAT	4
1.6. Configuring the Profiler Revolution SAT	5
2. TECHNICAL SPECIFICATIONS	12
3. BLOCK DIAGRAM	13
4. SAFETY INSTRUCTIONS	14
5. CONDITIONS OF WARRANTY	15

No part of this manual may be copied, reproduced, transmitted, transcribed or translated into any language without permission.

Unitron reserves the right to change the specifications of the hardware and software described in these manuals at any time.

Unitron cannot be held liable for any damages resulting from the use of this product. Specifications are subject to change without notice. 06/18

© Unitron - Frankrijklaan 27 - B-8970 Poperinge - Belgium

T +32 57 33 33 63 **F** +32 57 33 45 24

sales@unitrongroup.com

www.unitrongroup.com

1. INTRODUCTION

1.1. Product description

The Johansson Profiler Revolution SAT is an easy to use programmable filter amplifier and convertor for terrestrial signals with an extra Satellite input. The module optimizes satellite, terrestrial VHF/UHF and FM signals from multiple inputs with the goal to provide high quality images on your TV screen. The state-of-the-art programmable filter amplifier has no equivalent on the market due to its revolutionary technology:

- Read-out of input level strength: no need for field strength meter
- Can process more than 50 channels (Terrestrial and Satellite)
- Can convert a wide selection of Terrestrial channels
- Sharpest filters on the market (50 dB on adjacent channels)
- Real-time AGC on all individual multiplexes
- Flex matrix: complete flexibility in assigning filters from any input
- Made in Europe, for worldwide application
- The Profiler Revolution SAT facilitates straightforward configuration
- RED compliant (all classes 0/1/2/3/4)
- 6 inputs: SAT/ FM / 4 x VHF-UHF / > 50 Channels / AGC / 12-24 V remote power
- Product dimensions (H X W X D): 165mm x 217mm x 59mm

1.2. Typical installation

The Profiler Revolution SAT can be used to provide high quality television images (Terrestrial and Satellite) and FM signals in a wide range of projects, both in the hospitality as in the residential market. Typical buildings or infrastructures where the Profiler Revolution SAT can be used include, but are not limited to:

- Large and small hotels, hostels, bed and breakfasts, holiday parks
- Hospitals, rest homes, prisons, settlements
- Large and small multi-dwelling units

1.3. Package contents

- 1 Profiler Revolution SAT (ref. 6702)
- 1 Power Adapter Cord (180cm)

1.4. Hardware installation

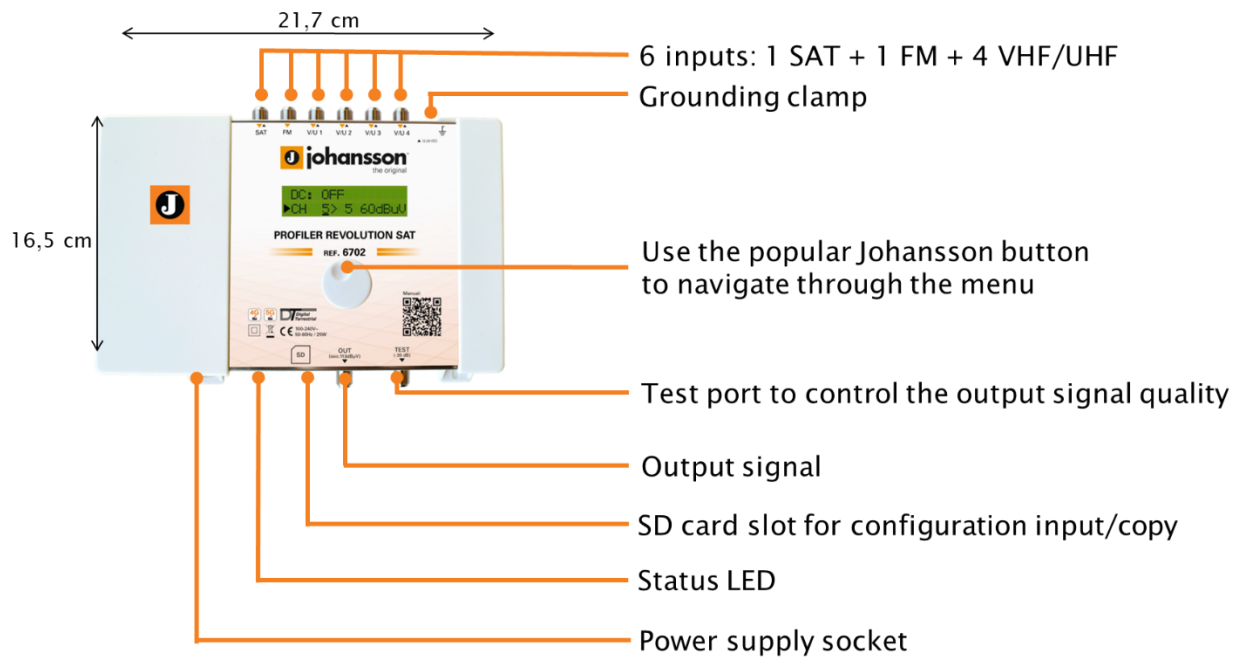
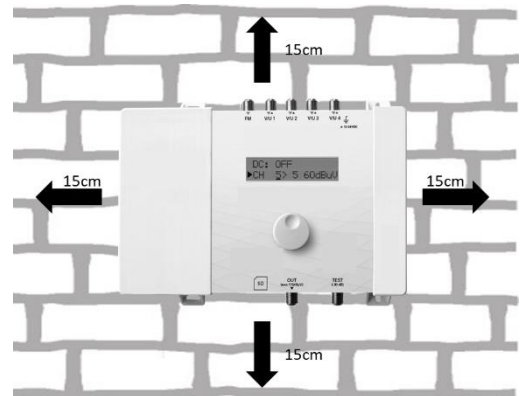

FIGURE 1: TOP VIEW OF PRODUCT

1.5. Mounting the Profiler Revolution SAT



- **Important:** Mount the module vertically to a wall in a well-ventilated room and leave a minimum space of 15 cm around the product to guarantee a maximum ventilation of the product
- Connect an earth wire to the grounding clamp
- Connect the power adapter cord to the power supply socket. Check the status LED for the indication of DC power presence
- Connect the SAT, VHF/UHF and/or FM inputs to the Profiler Revolution SAT
- Connect a coaxial cable to the output connector for distribution of the signal
- Connect a network analyser to the test port to control the signal quality
- Configure the Profiler Revolution SAT using the rotary button, see below
- Optionally: insert an SD card in the SD card slot to upload the configurations of a previous module or to copy the configuration to another module
- The power adapter can easily be replaced without disconnecting the product. To do so, open the top left plastic cover by pushing the click at the opposite side of the mains connector



1.6. Configuring the Profiler Revolution SAT

NAVIGATING THROUGH THE MENU

Use the Johansson rotary/push button to navigate through the menu. This is very straightforward and simple. The table below shows how the rotary/push should be used:

	<p>Push the button 2s to enter the basic configuration.</p> <p>Push the button to confirm your selections.</p>
	<p>When rotating the button, you scroll through the different screens.</p>

MENU OVERVIEW

	INPUT SAT	INPUT FM	INPUT V/U 1 - 4	OUTPUT	ADVANCED	LOAD SD PRESET	SAVE SD PRESET	EXIT	
	STATE	GAIN	PRE-AMPLIFIER	LEVEL	LANGUAGE	PRESET X	CREATE PRESET	LOCK	
	DC		DC	SLOPE	REGION		DELETE ALL	NO LOCK	
	GAIN		ADD 1 CHANNEL		DC VOLTAGE				
	SLOPE		ADD 2 CHANNELS		FILTER				
					FW VERSION				
					SERIAL NUMBER				
					FORMAT CARD				
					UPGRADE FW				

REGION/COUNTRY SETTINGS







IMPORTANT! Before starting the configuration, it is advised to set the correct region or country. Unpower the unit, push the button and keep pushing the button while you repower the unit. Release the button when the display shows "RESET FINISHED". Now the product is reset and will ask you to enter country or region. This will amongst others determine the channel plan for VHF and UHF and the DC voltage for the inputs (12 or 24V).



DISPLAY READOUT	EXPLANATION
	<p>To activate the correct channel frequency plan, select the country or region where the Profiler Revolution SAT is situated. Rotate to select and confirm by tapping the rotary button.</p> <p>The default setting is Europe. The Profiler Revolution SAT is also operational in the following countries/regions: Australia, Brazil, China, Hongkong, Italia, New-Zealand, Russia, South Africa, UK and USA.</p>

All the following menu items can be accessed without the reset procedure.

Push the rotary button for 2 seconds to access the menu

INPUT SETTINGS



DISPLAY READOUT	EXPLANATION
	<p>Tap the rotary button to enter the INPUT SAT menu. Rotate the button to navigate through the submenu.</p>
	<p>STATE: Select the state of the SAT INPUT: ON or OFF DC: Choose the voltage (13V, 13V + TONE, 18V, 18V + TONE or BYPASS)</p>
	<p>GAIN: set the satellite gain (from 20 to 40 dB) SLOPE: set the slope (from -9 to 0 dB) After INPUT SAT is configured, scroll up to the top of the menu (INPUT SAT), tap the rotary button and scroll right to INPUT FM.</p>
	<p>Tap the rotary button to enter the INPUT FM menu. Rotate the button to navigate through the submenu.</p>
	<p>To filter and amplify an FM signal, tap GAIN, select the gain of the input FM signal (15 to 35 dB) and tap to confirm. Remark: DAB should be added via V/U input 1-4.</p>
	<p>After INPUT FM is configured, scroll up to the top of the menu (INPUT FM), tap the rotary button and scroll right to INPUT V/U 1. Tap INPUT V/U 1 to enter the menu to configure input 1.</p>



DISPLAY READOUT	EXPLANATION
	<p>Rotate the rotary button to scroll down in the submenu of INPUT V/U 1.</p>
	<p>PRE-AMPLI: The internal amplifier is by default ON, only in case of very strong incoming signals (if the strongest channel on that input is higher than 80dBμV), it can be advised to switch this OFF.</p>
	<p>DC: Decide whether the input should provide power to an external amplifier. Choose between OFF or 12 V. Remark: If the external amplifier needs 24 V, you can change this in advanced settings (see further).</p>

There are 2 modes to add channels to each input:





- **ADD 1 CHANNEL:** This is the standard mode where you add channels one by one to an input. This implies that channels are filtered and levelled individually.
- **ADD 2 CHANNELS:** In this mode you add 2 adjacent channels to an input. This enables you to process more than 50 channels. The 2 channels are processed together as 1 cluster. This means that the input level, shown on the display, and the output level are both the sum of signal strength of the 2 channels.

For optimal performance we recommend to only add single channels, unless you need to process a lot of channels.

DISPLAY READOUT	EXPLANATION
	<p>ADD 1 CHANNEL: Tap ADD 1 CHANNEL and choose the channel you want to receive. Tap to confirm. By changing the second value, you can decide where to place the channel at the output. Tap to confirm. 1 CHANNEL mode is indicated by a '>'</p>
	<p>CONVERSION OF A CHANNEL: If the 2 channel numbers indicate the same value, there is no conversion. If the 2 channel numbers indicate a different value, there is conversion. In this example, if the display is set to show 21> 5, the received channel 21 is converted or frequency shifted to the output channel 5.</p>



DISPLAY READOUT	EXPLANATION
	<p>ADD 2 CHANNELS: Tap ADD 2 CHANNELS and choose the adjacent pair of channels you want to receive. Tap to confirm. 2 CHANNELS mode is indicated by a '+' <u>When adding 2 channels, conversion is not possible.</u></p>
	<p>Remark1: The first channel will determine if your input becomes a VHF only or UHF only input. This means that VHF and UHF cannot be combined in one input. Remark 2: The value 60dBμV (in the bottom right corner) indicates the incoming level of the channel. Remark 3: For EU, Italy and New-Zealand region, Channel 13 (230-240MHz) and "VHF" can be used. "VHF" means the whole band is treated in 1 bandpass filter from 174 to 240MHz. Channels "VHF" and CH13 cannot be converted and are not part of the 2-channel mode, as they have different bandwidths.</p>

Note: it might take up to 20 seconds for the AGC to stabilize the signal levels



DISPLAY READOUT	EXPLANATION
	<p>To add another channel, scroll down to ADD 1 CHANNEL or ADD 2 CHANNELS and tap to confirm.</p>
	<p>To prevent bad quality or scrambled images, make sure that only one input channel is assigned to one output channel. If 2 channels are assigned to the same output channel, a star (*) will appear.</p>
	<p>The same applies for adding 2 channels. Make sure that each output channel is selected only once.</p>
	<p>Add all the input channels you want and assign them to the output channels.</p>

After this, the correct LTE filter will be set for the input (possible filters are 694MHz, 790MHz or OFF). If the channels are lower than 48, the 694MHz filter is activated. The 790MHz filter is activated for the channels lower than 60.

To delete a (pair of) channel(s), position the arrow on the channel and press the rotary button 3 seconds.





DISPLAY READOUT	EXPLANATION
	To delete a (pair of) channel(s), position the arrow on the channel and press the rotary button 3 seconds.
	When you have added all the channels to INPUT V/U 1, and you want to add channels to the other inputs, scroll up to the top of the menu (to INPUT V/U 1), tap the button and scroll to the next input. Repeat the previous steps for all input channels.

OUTPUT SETTINGS



DISPLAY READOUT	EXPLANATION
	Define the OUTPUT LEVEL of the output signal. Range between 93 dB μ V and 113 dB μ V (default output level is 103 dB μ V). Check the output via a network analyser on the -30dB test port. Note: The more channels you select, the less output power you should give (e.g. 106 to 110 dB μ V for 10 channels).
	A SLOPE of up to -9dB can be set between the beginning of BIII and the end of UHF to compensate for cable losses. 0dB means all channels have the same output level (see previous display readout), -9dB means the beginning of BIII (174MHz) is 9dB weaker than the end of UHF.

Note: In the OUTPUT menu, you define the output level in dB μ V of the MUX's. The Profiler Revolution SAT has enough gain to guarantee this output level under all input conditions. In case a slope has been set, the output level indicated on the display will be the output level of the highest frequency MUX.





ADVANCED SETTINGS

DISPLAY READOUT	EXPLANATION
	<p>The language of the Profiler Revolution SAT can be set to English, Italian, Spanish or French.</p>
	<p>Tap REGION to check to which region/country the Profiler Revolution SAT is set. To change the region/country, a hard reset is required (see instructions above (cfr. REGION/COUNTRY SETTINGS)).</p>
	<p>Define DC VOLTAGE for the inputs, choose between 12V or 24V. This is a global setting for all inputs, each input can then be switched between OFF or this value. (cfr. STEP 2). All countries are set by default on 24V, except UK which is set by default on 12V.</p> <p>There are 3 options to select the filter bandwidth: "Best MER" has the widest filter bandwidth. This will give the best MER in case where there are no adjacent Multiplexes. "Sharp" has the narrowest bandwidth and will work best when there are difficult adjacent Multiplexes but this could be at the expense of the overall MER performance. "Optimal" is the compromise between the other 2 options. This is the best setting in 95% of the cases.</p>
	<p>Tap FW VERSION to check the firmware version of the device.</p> <p>Tap SERIAL NUMBER to check the serial number of the device.</p> <p>To format the SD CARD, tap FORMAT CARD.</p> <p>To upgrade the firmware of the device, tap UPGRADE FW. Make sure the new firmware file is on the SD Card before upgrading.</p>

SD CARD SETTINGS

DISPLAY READOUT	EXPLANATION
	To upload settings from a SD card, tap LOAD SD PRESET. This will copy the configuration file from the SD CARD to the device.
	To save the device settings on the SD CARD, go to SAVE SD PRESET and tap on CREATE PRESET.
	It is possible to create multiple presets. Therefore, tap CREATE PRESET after each modification of the settings. To delete all presets, press DELETE ALL.

EXIT SETTINGS

DISPLAY READOUT	EXPLANATION
	To avoid unauthorized people changing the settings, all Profiler products can be locked with a security code.
	Select LOCK and SET LOCK CODE. When the lock code is set, the device will shut down.
	When you restart the device, you will now have to enter the correct lock code. <u>Remark:</u> If you forgot the lock code, you can always use the value 50. This master code is fixed and cannot be changed.
	If you do not want to work with a lock code, go to EXIT and tap NO LOCK.

2. TECHNICAL SPECIFICATIONS

Profiler Revolution SAT 6702		
Inputs	-	1 SAT + 1 FM + 4 VHF/UHF
Outputs	-	1 main (SAT-FM-VHF-UHF) + 1 test port (-30dB)
Frequency range	MHz MHz MHz MHz	SAT: 950 - 2400 FM: 88 - 108 VHF: 174 - 240 UHF: 470 - 862
LTE protection	MHz	Automatic selection: 694, 790 or OFF
Input level	dBμV dBμV dBμV dBμV	SAT: 40 - 95 FM: 37 - 77 VHF: 40* - 109 UHF: 40* - 109
SAT output power (-35dBc/IM3 2 carriers)	dBμV	119
FM Output power (60dB/IM3)	dBμV	113
VHF/UHF Output power (60dB/IM3)	dBμV	120
VHF/UHF Output power with 1 MUX	dBμV	113
VHF/UHF Output power with 6 MUX	dBμV	110
Conversion	-	Yes (from any VHF-UHF channel to any VHF-UHF channel)
Gain	dB dB dB dB	SAT: 40 FM: 35 VHF: >45 UHF: >55
Gain adjustment	dB dB -	SAT: 20 FM: 20 VHF/UHF: Channel AGC
Noise figure	dB	SAT: 8
General attenuator	dB	20
Slope adjustment	dB dB	SAT: 12 VHF/UHF: 9
Selectivity	dB dB/1MHz	SAT: 40 (@862 MHz) VHF/UHF: 35
Output MER	dB dB	VHF: 35 UHF: 35
ESD protection	-	All inputs
DC @ VHF/UHF input	V	12 or 24
DC Load current @ VHF/UHF input	mA	100 (total for the 4 VHF/UHF inputs)
DC @ SAT input	-	13V/18V/Bypass & 0/22kHz selectable by SW
DC Load current @ SAT input	mA	300
RED compliance selectivity classification	-	0 – 1 – 2 – 3 – 4
SD port	-	Yes (for copy configuration)
Operating temperature	°C	-5 to +50
Power Supply	Vac	100 - 240
Power consumption	W	25
Dimensions	mm	217 x 165 x 59
Weight	kg	0,85

* For 64QAM with code rate 3/4

3. BLOCK DIAGRAM

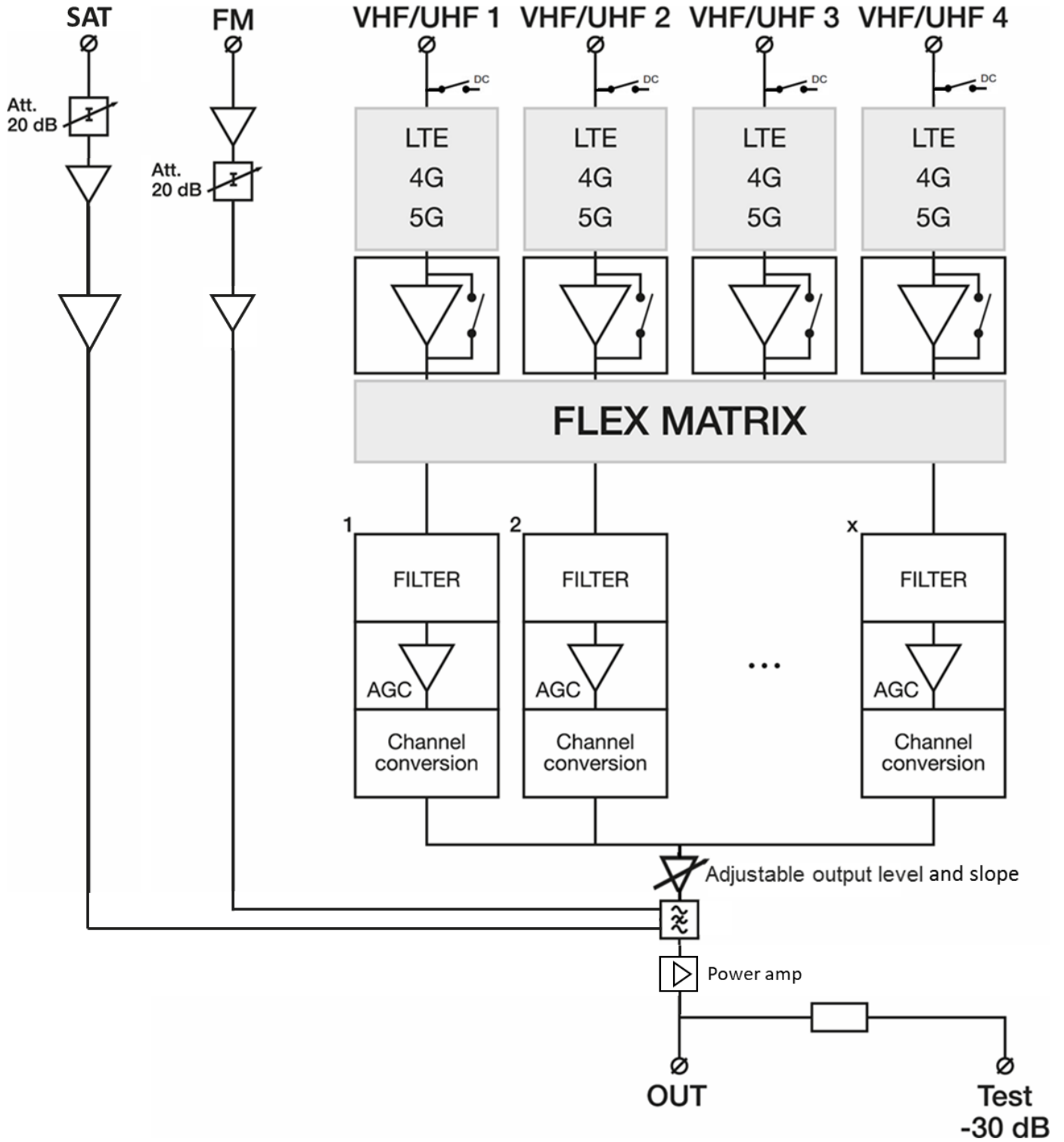

4. SAFETY INSTRUCTIONS



Read these instructions carefully before connecting the unit



To prevent fire, short circuit or shock hazard:

- Do not expose the unit to rain or moisture.
- Install the unit in a dry location without infiltration or condensation of water.
- Do not expose it to dripping or splashing.
- Do not place objects filled with liquids, such as vases, on the apparatus.
- If any liquid should accidentally fall into the cabinet, disconnect the power plug.



To avoid any risk of overheating:

- Install the unit in a well aired location and keep a minimum distance of 15 cm around the apparatus for sufficient ventilation
- Do not place any items such as newspapers, tablecloths, curtains, on the unit that might cover the ventilation holes.
- Do not place any naked flame sources, such as lighted candles, on the apparatus
- Do not install the product in a dusty place
- Use the apparatus only in moderate climates (not in tropical climates)
- Respect the minimum and maximum temperature specifications



To avoid any risk of electrical shocks:

- Connect apparatus only to socket with protective earth connection.
- The mains plug shall remain readily operable
- Pull out power plug to make the different connections of cables
- To avoid electrical shock, do not open the housing of adapter.



Maintenance



Only use a dry soft cloth to clean the cabinet.



Do not use solvent



For repairing and servicing refer to qualified personnel.



Dispose according your local authority's recycling processes

5. CONDITIONS OF WARRANTY

Unitron N.V. warrants the product as being free from defects in material and workmanship for a period of 24 months starting from the date of production indicated on it. See note below.

If during this period of warranty the product proves defective, under normal use, due to defective materials or workmanship, Unitron N.V, at its sole option, will repair or replace the product. Return the product to your local dealer for reparation.

THE WARRANTY IS APPLIED ONLY FOR DEFECTS IN MATERIAL AND WORKMANSHIP AND DOES NOT COVER DAMAGE RESULTING FROM:

- Misuse or use of the product out of its specifications,
- Installation or use in a manner inconsistent with the technical or safety standards in force in the country where the product is used,
- Use of non-suitable accessories (power supply, adapters...),
- Installation in a defect system,
- External cause beyond the control of Unitron N.V. such as drop, accidents, lightning, water, fire, improper ventilation...

THE WARRANTY IS NOT APPLIED IF

- Production date or serial number on the product is illegible, altered, deleted or removed.
- The product has been opened or repaired by a non-authorized person.

NOTE

Date of production can be found in the product's serial number code. The format will either be "YEAR W WEEK" (e.g., 2017W32 = year 2017 week 32) or "YYWW" (e.g., 1732 = year 2017 week 32).



www.unitrongroup.com

UNITRON NV
Frankrijklaan 27
B-8970 Poperinge
Belgium

T +32 57 33 33 63
F +32 57 33 45 24

sales@unitrongroup.com

www.unitrongroup.com