

UT25CL

Cable Locator

User Manual



Preface

Thank you for purchasing this brand new product. In order to use this product safely and correctly, please read this manual thoroughly, especially the Safety Instructions part.

After reading this manual, it is recommended to keep the manual at an easily accessible place, preferably close to the device, for future reference.

Limited Warranty and Liability

Uni-Trend guarantees that the product is free from any defect in material and workmanship within one year from the purchase date. This warranty does not apply to damages caused by accident, negligence, misuse, modification, contamination or improper handling. The dealer shall not be entitled to give any other warranty on behalf of Uni-Trend. If you need warranty service within the warranty period, please contact your seller directly.

Uni-Trend will not be responsible for any special, incidental or subsequent damage or loss caused by using the device.

Table of Contents

1.	Overview.....	5
2.	Accessories	5
3.	Safety Information	5
	3.1 Electrical Symbols	5
	3.2 Safety Instructions and Precautions	6
4.	Transmitter Components.....	9
	4.1 Transmitter Appearance	9
	4.2 Descriptions of Components	9
	4.3 Descriptions of Display.....	10
5.	Receiver components.....	11
	5.1 Receiver Appearance	11
	5.2 Options of Components.....	11
	5.3 Description of Display.....	12
6.	Setting.....	13
	6.1 UT25CL-T Setting	13
	6.1.1 CODE Setting.....	13
	6.1.2 LEVEL Setting	13
	6.1.3 Buttons Setting.....	14
	6.1.4 Descriptions of Keytone	14
	6.2 UT25CL-R Setting	15
	6.2.1 Auto/Manual Mode Setting (In Cable Tracking Mode).....	15
	6.2.2 Adjust the Reception Sensitivity in MANUAL Mode	15
	6.2.3 NCV Mode Switching:	16
	6.2.4 Buttons Setting.....	16
	6.2.5 Descriptions of Keytone	16
7.	Key Applications	16
	7.1 Track Energized and Deenergized Cables	18
	7.1.1 Connect test leads to the transmitter	18
	7.1.2 Setting of UT25CL-T transmitter	19
	7.1.3 Use of UT25CL-R receiver (In automatic scanning mode).....	20
	7.1.4 Use of UT25CL-R receiver (In manual scanning mode)	21
	7.2 Identify Circuit Breaker and Fuse (Energized and Deenergized)	22
	7.2.1 Connect test leads	23
	7.2.2 Setting of UT25CL-T transmitter.....	23
	7.2.3 Use of UT25CL-R receiver.....	24
	7.3 NCV Mode and Passive Tracking	25
8.	Special Applications	26
	8.1 Track the Cable of GFCI-Protected Circuit	26
	8.2 Identify Breakpoints/Opens	26

8.3 Identify Shorts.....	27
8.4 Track Cables in Metal Pipe	28
8.5 Track Shielded Cables	29
8.5.1 Ground the far end of shielded cable	29
8.5.2 Disconnect the far end of shielded cable from the grounding	29
8.6 Track Underground Wire	30
8.7 Track Low-Voltage Wire and Data Cable	31
8.8 Identify the Specific Cable in Cable Harness.....	31
8.9 Draw a Circuit Diagram Using the Connection of Test Leads.....	32
8.10 Track the Circuit Breaker in the System with Illumination Dimmer.....	32
9. External Voltage Measurement and ELV Function (UT25CL-T).....	33
9.1 External Voltage Measurement.....	33
9.2 ELV Function	34
10. Technical Specifications	35
10.1 Transmitter Specifications	35
10.2 Receiver Specifications.....	36
11. Maintenance.....	37
11.1 Battery Replacement (UT25CL-T).....	37
11.2 Battery Type and Threshold (Transmitter).....	37
11.3 Fuse Replacement (UT25CL-T).....	38
11.4 Battery Replacement (UT25CL-R)	39
11.5 Battery Type and Threshold (Receiver).....	39

1. Overview

UT25CL Handheld Cable Locator can be used to detect the path of low-voltage cables buried in ground (such as cabling inside wall); test and diagnose opens, shorts and other problems occurring at cabling; and detect if the tested cable is energized. The transmitter can display corresponding voltages (voltage of energized cable: $\geq 8V$), and the receiver can simultaneously display the signal strength, transmitter code, transmitter power level, low battery, etc. UT25CL has multiple advantages including accurate measurement, easy operation, visualized display, and more, making it an ideal tool for low-voltage cabling engineering, engineering and maintenance of metal conductors, etc.

2. Accessories







Open the package and take out the Meter to check if any accessory is missing or damaged.



- **UT25CL-T transmitter**-----1 pc
- **UT25CL-R receiver**-----1 pc
- **Dual in-line test leads (red + black)**-----1 pair
- **Alligator clips (red + black)**-----1 set
- **Lantern-tip test probe (red + black)**-----1 pair
- **AC polarized plug wire**-----1 pc
- **Quick guide start**-----1 pc
- **1.5V AA alkaline battery**-----6 pcs
- **1.5V AAA alkaline battery**-----6 pcs

If any accessory is missing or damaged, please contact your supplier immediately.

3. Safety Information

3.1 Electrical Symbols

	AC (Alternating Current)		DC (Direct Current)
	Warning		High voltage
	Double insulated		Grounding

	Conform to European Union standards		UKCA certification mark
	Do not place equipment and its accessories in the trash. Please dispose properly according to the local regulation.		
CAT III	Applicable to test and measure the circuit connected with the power distribution part of building's low-voltage MAINS installation.		

3.2 Safety Instructions and Precautions



- Warning: To avoid electric shock, fire or personal injury, please read through the user manual.
- After reading the “Safety Information”, please keep it and the user manual along with the Meter in a proper place for future use.
 - To ensure safe use, the user must adhere to the safety instructions and warning affixed to the product. Failure to follow the operating instructions may compromise or lose the protection provided by the Meter.
 - Please check the Meter and the test leads before use. The insulation of the test lead shall not be damaged or broken. If the test lead is damaged, please replace it immediately (The rated voltage, frequency and type of the replacement leads must be same with that of the Meter). Use only test leads approved by safety certification body.
 - If any problem is found, such as bare test lead, damaged casing, abnormal display, damaged accessory, etc., please stop use immediately and prevent inadvertent use.
 - For safety, please do not alter the internal wiring of the Meter to avoid damaging the Meter and posing safety risks.
 - Do not use or keep the Meter in places with high temperature and high humidity. If the Meter gets damped, its performance may degrade.
 - It is forbidden to use the Meter without the cover closed well, otherwise it may present a risk of electric shock.
 - Please ensure the user’s hands, shoes, clothing, ground, circuits and components are dry.
 - When the Meter is performing measurement, please do not make contact with the bare wire, connector, unused input terminal or circuit under testing.
 - Use caution when working with voltage over 30V (DC/AC), please grip the test lead behind the finger guard to avoid electric shock.

- Set the Meter at maximum range if the measured range is unknown. The measured signal is not allowed to exceed the specified extreme limit, to prevent electric shock or damage to the Meter.
- Do not apply overrated voltage or current between terminals, or between any terminal and earth ground.
- Remove the test leads from the Meter before opening the battery cover.
- Please grip the Meter behind the finger protector when using the probe.
- Disconnect the test leads with the measured circuit after each measurement operation is completed.
- In CAT III/CAT IV measurement locations, please ensure the test lead shield is pressed firmly in place to avoid a risk of electric shock. In CAT II measurement locations, the test lead shield can be removed so as to perform testing on recessed conductors such as wall outlets. Take care not to lose the shields.
- If the low battery symbol appears on the LCD, please replace the battery immediately to ensure measurement accuracy.
- Please measure the known intrinsic voltage of the Meter before use to ensure the Meter functions normally.
- If the product is not used in the way specified by the manufacturer, the protection provided by the product can be compromised.
- Please check the batteries before use or replacement. The batteries must be installed according to the correct polarity.
- Turn off the power after measurement is completed. If the product is not used for a long time, please remove the batteries from the Meter to avoid leakage. If battery leakage occurs, please do not use the Meter before the customer service personnel perform check on it.
- Battery acid (electrolyte) is high-alkalinity substance and can conduct electricity (There is a risk of acid burn). If battery acid comes into contact with your skin or clothing, please scour with a large amount of water immediately. In case that battery acid enters your eyes accidentally, please scour with a large amount of water immediately and get medical treatment in time.
- Please keep the batteries in places to which children cannot access, to prevent children or pets from swallowing the batteries.
- Do not dismantle or short the batteries or throw them in fire. It is forbidden to charge non-

chargeable batteries, otherwise it may pose a risk of explosion.

- Power off the Meter before cleaning or maintenance. Disconnect the connected measured cable or other accessories from the Meter and all measured objects.
- Please do not immerse the Meter into water or other liquids. Intrusion of any liquid to the Meter is not allowed.
- Please wipe the Meter case with damp cloth and mild detergent. Do not use abrasives or solvents.
- The calibration or maintenance must be performed by qualified repair personnel or designated repair department.
- If the Meter is equipped with replaceable fuse, please adhere to the following operating instructions:
 - 1) Power off the Meter before replacing the fuse and disconnect the connected measured cable.
 - 2) Use only fuse with designated type and current rating. Do not use wrong or repaired fuse or connect the fuse block, otherwise it may cause fire.

Note: It is normal that weak spark may occur momentarily when UT25CL-T is used as a voltage meter to measure external voltage.

4. Transmitter Components

4.1 Transmitter Appearance

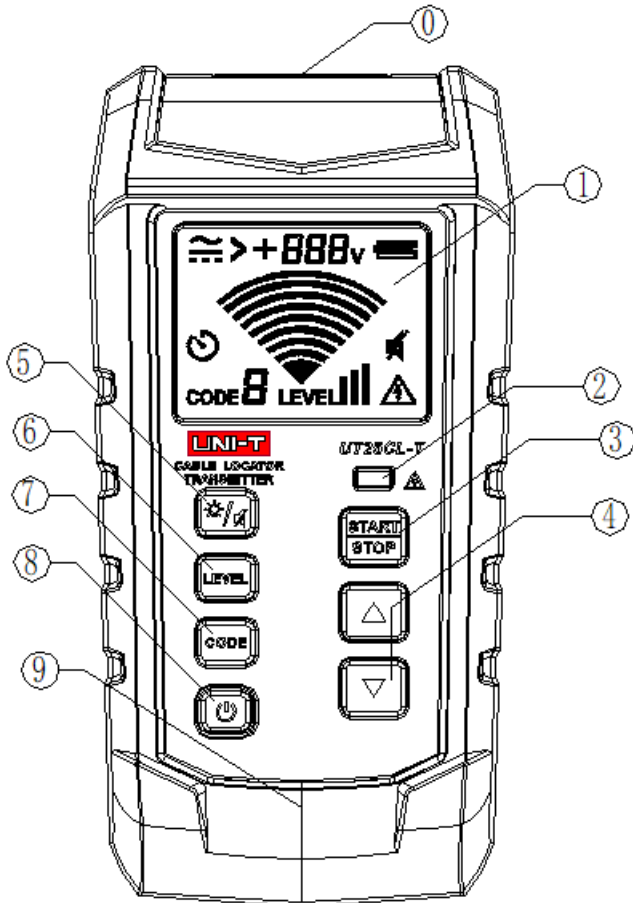

4.2 Descriptions of Components

0	Input/output terminal: Used to connect with multiple accessories (i.e., AC polarized plug) for signal measurement/output.
1	LCD screen with backlight.
2	ELV indicator light: If the voltage of the input port exceeds the specified voltage when the transmitter is powered off, the LED lights up red and its brightness increases as the voltage rises.
3	Button for starting/stopping signal transmission: When there is no signal emitted, short press this button to start signal transmission, short press again to stop signal transmission.
4	Up/Down button (Enabled when transmission is stopped and the CODE and LEVEL are set): <ul style="list-style-type: none"> ● When the CODE symbol flashes, short press the Up/Down button to set the CODE to 0, 1, 2, 3, 4, 5, 6 or 7. The default code is 5. ● When the LEVEL symbol flashes, short press the Up/Down button to set the LEVEL to I, II

	or . The default level is “”.
5	Backlight/Mute button: Short press to turn on/off the backlight; long press to turn on/off the mute mode.
6	LEVEL button (Enabled when transmission is stopped): Short press to enter/exit the LEVEL setting.
7	CODE button (Enabled when transmission is stopped): Short press to enter/exit the CODE setting.
8	Power button: Long press this button for >1s to turn on the transmitter; or long press >1s in power-on state to turn off the transmitter.
9	The buzzer is designed in here.

4.3 Descriptions of Display

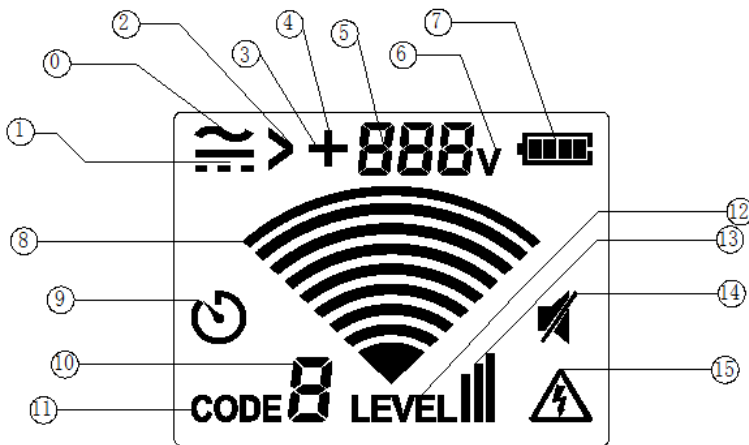

0	The symbol “” appears when the input/output port is connected with AC power supply.
1	The symbol “” appears when the input/output port is connected with DC power supply.
2	The symbol “” appears when the input/output port is connected with an AC/DC power supply greater than 480V.
3	When the input/output port is connected with DC power supply, and the red input port is connected with DC negative pole and the black port is connected with positive pole, the symbol “” appears.
4	When the input/output port is connected with DC power supply, and the red input port is connected with DC positive pole and the black port is connected with negative pole, the symbol “” appears.
5	The actual measured voltage (when the input voltage is $\geq 8V$).
6	A voltage symbol
7	Battery power level (including 4 levels)
8	When signal is emitted, this dynamic symbol will be refreshed cyclically.
9	Auto-off (APO symbol)
10	This is the current code value. When setting the code, the current set code (code value: 0~7) will be displayed. The default code is 5.

11	This is the code symbol. It flashes when setting code.
12	This symbol denotes the level of the transmission power. It flashes when setting the power level.
13	This is the current power level. When setting the power, the current set power level (III, II and I) will be displayed.
14	This symbol appears when the buttons are set in mute mode.
15	If input voltage greater than 25V is applied to the port, this symbol will be displayed; if greater than 480V, it will flash.

5. Receiver components

5.1 Receiver Appearance

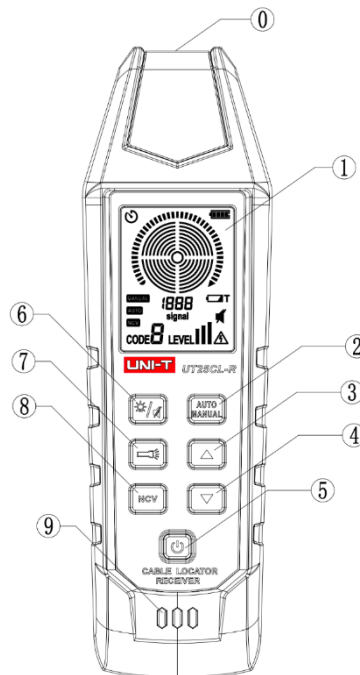

5.2 Options of Components

0	This is the cable tracking end and the NCV sensor is designed in here.
1	LCD screen with backlight.
2	AUTO/MANUAL button (Enabled in cable tracking mode): Short press this button in cable tracking mode to switch between AUTO and MANUAL modes (Default mode: AUTO).
3	UP button (Enabled in cable tracking mode and MANUAL setting) In MANUAL mode (in cable tracking mode), short press this button to increase the reception sensitivity (0~8). When the sensitivity is at 8, short press to switch to AUTO mode.
4	DOWN button (Enabled in cable tracking mode) 1). In AUTO mode (in cable tracking mode), short press this button to switch to MANUAL mode (Default: Position 6). 2). In MANUAL mode (in cable tracking mode), the reception sensitivity (8~0) can be decreased.
5	Power button: Long press this button for >1s to turn on the receiver; or long press >1s in power-on state to turn off the receiver.

6	Backlight/Mute button: Short press to turn on/off the backlight; long press to turn on/off the mute mode.
7	Flashlight button: Short press to turn on/off the flashlight.
8	NCV button: 1). Cable tracking mode is the default mode after boot-up. Short press this button to switch to NCV mode. 2). In NCV mode, short press to switch to AUTO mode (in cable tracking mode).
9	The buzzer is designed in here.

5.3 Description of Display

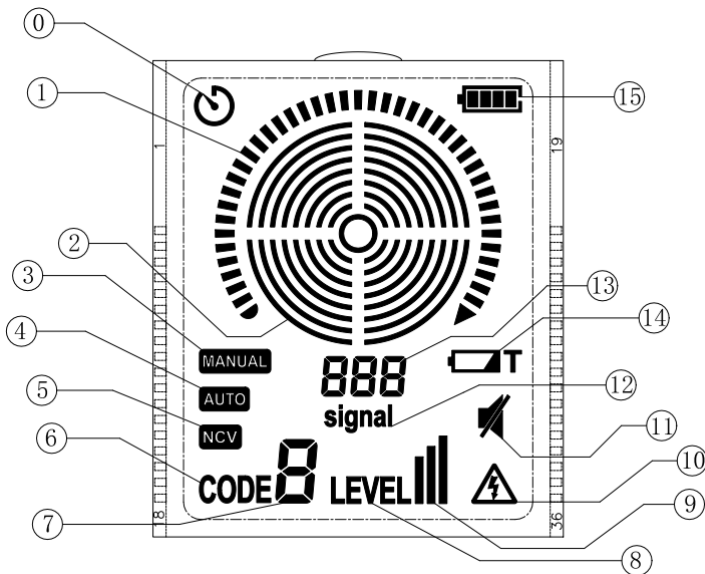

0	Auto-off (APO symbol)
1	Analog bar graph
2	Sensitivity level
3	MANUAL mode (in cable tracking mode)
4	AUTO mode (in cable tracking mode)
5	NCV mode
6	CODE symbol (Displayed in cable tracking mode)
7	Transmitter code (0~7). This code is displayed in cable tracking mode.
8	LEVEL symbol (Displayed in cable tracking mode)
9	Transmitter power level (Displayed in cable tracking mode)
10	This symbol means non-contact voltage (NCV) is sensed. (NCV signal is sensed in cable tracking mode or in NCV mode)
11	This symbol appears when the buttons are set in mute mode.
12	A signal symbol (Displayed in cable tracking mode)
13	Relative signal amplitude (Displayed in cable tracking mode)
14	The symbol means the transmitter is in low battery state. (Displayed in cable tracking mode)
15	Battery power level (including 4 levels)

6. Setting

6.1 UT25CL-T Setting

6.1.1 CODE Setting

1. The default code is 5 when the transmitter is powered on.
2. The transmitter is in power-on state by default (Transmission is not started by the transmitter), short press the START/STOP button to stop transmission when transmission is started by the transmitter. When the CODE button is short pressed, the CODE symbol flashes for 0.5s, as shown in Figure 6.1.1a.

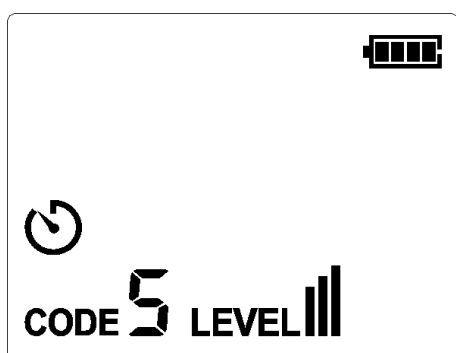

Figure 6.1.1a

3. When the code symbol flashes, short press the Up/Down button to set the code to 0, 1, 2, 3, 4, 5, 6 or 7. The default code is 5. As shown in Figures 6.1.1b and 6.1.1c.

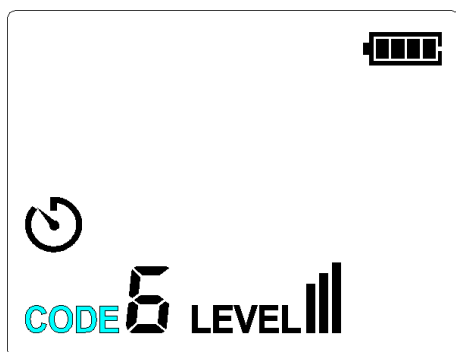

Figure 6.1.1b CODE Increasing

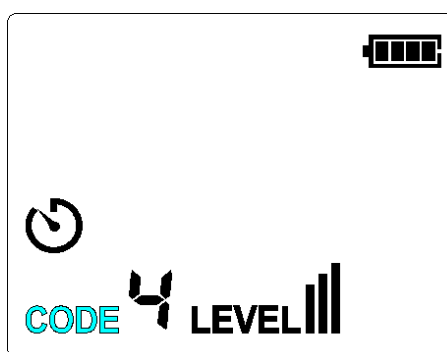

Figure 6.1.1c CODE Decreasing

4. Short press again the CODE button or LEVEL button (6.1.2 LEVEL Setting) or START/STOP button to exit the code setting.

6.1.2 LEVEL Setting

1. The default code is III when the transmitter is powered on.
2. The transmitter is in power-on state by default (Transmission is not started by the transmitter), short press the START/STOP button to stop transmission when transmission is started by the

transmitter. When the LEVEL button is short pressed, the LEVEL symbol flashes for 0.5s, as shown in Figure 6.1.2a.

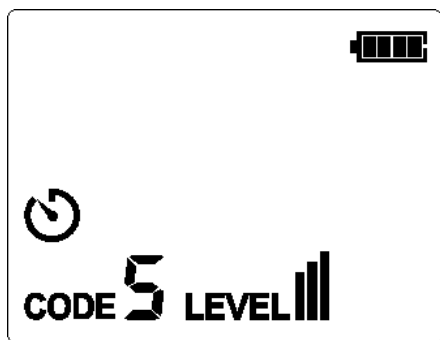

Figure 6.1.2a

- When the LEVEL symbol flashes, short press the Up/Down button to set the level to **|||**, **||** or **I**. The default level is **|||**. As shown in Figure 6.1.2b

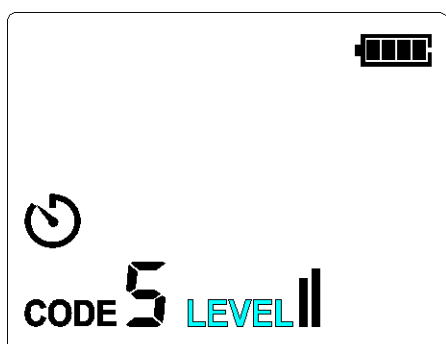

Figure 6.1.2b LEVEL Increasing/Decreasing

- Short press again the LEVEL button or CODE button (6.1 CODE Setting) or START/STOP button to exit the level setting.

6.1.3 Buttons Setting

- Short press the Backlight/Mute button to turn on/off the backlight; long press to turn on/off the Mute mode.
- Short press the START/STOP button to turn on/off signal transmission.
- When the transmitter transmits signal, the functions activated by short pressing the CODE, LEVEL, UP and DOWN buttons are disabled.
- When the transmitter does not transmit signal, the functions activated by short pressing the CODE, LEVEL, UP and DOWN buttons are enabled.
- After the transmitter powers on normally, the START/STOP and Backlight/Mute buttons can be used normally in any mode and situation.
- Long press the power button for >1s to enable the button function.

6.1.4 Descriptions of Keytone

- When the button function is enabled and the transmitter is not muted, the keytone is a high-

pitched short sound

- When the button function is disabled and the transmitter is not muted, the keytone is a low-pitched short sound
- In mute mode, all buttons are muted.

6.2 UT25CL-R Setting

6.2.1 Auto/Manual Mode Setting (In Cable Tracking Mode)

- The default mode is AUTO scanning mode when the receiver powers on.
- The receiver is in power-on state by default, short press the AUTO/MANUAL button to switch to MANUAL scanning mode (reception level mode is 6), as shown in Figures 6.2.1a and 6.2.1b.

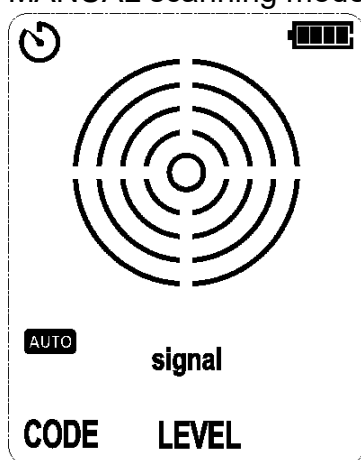

Figure 6.2.1a Auto Mode

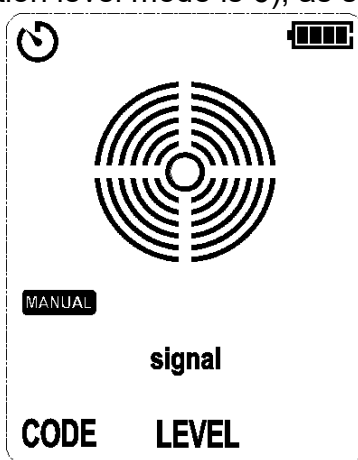

Figure 6.2.1b Manual Mode

- In AUTO scanning mode, short press the DOWN button to switch to MANUAL mode (default reception sensitivity: 6).
- When the receiver is in MANUAL scanning mode and its reception sensitivity is 8, short press the UP button to switch to AUTO mode.

6.2.2 Adjust the Reception Sensitivity in MANUAL Mode

- Power on the receiver and then it enters MANUAL mode (default reception sensitivity: 6), as shown in Figure 6.2.1b.
- In MANUAL mode, short press the UP button to adjust the sensitivity from 0 to 8. When the sensitivity is 8, short press the UP button to switch to AUTO mode.
- In MANUAL mode, short press the DOWN button to adjust the sensitivity from 8 to 0. In AUTO mode, short press the DOWN button to switch to MANUAL mode.

Note: The LEVEL and CODE shown on UT25CL-R are data sent from UT25CL-T. These data cannot be adjusted on UT25CL-R.

6.2.3 NCV Mode Switching:

1. The receiver is in power-on state: In AUTO or MANUAL mode (in cable tracking mode), short press the NCV button to switch to NCV mode. In NCV mode, short press the NCV button to switch to AUTO mode (in cable tracking mode). As shown in Figures 6.2.3a, 6.2.3b and 6.2.3c.

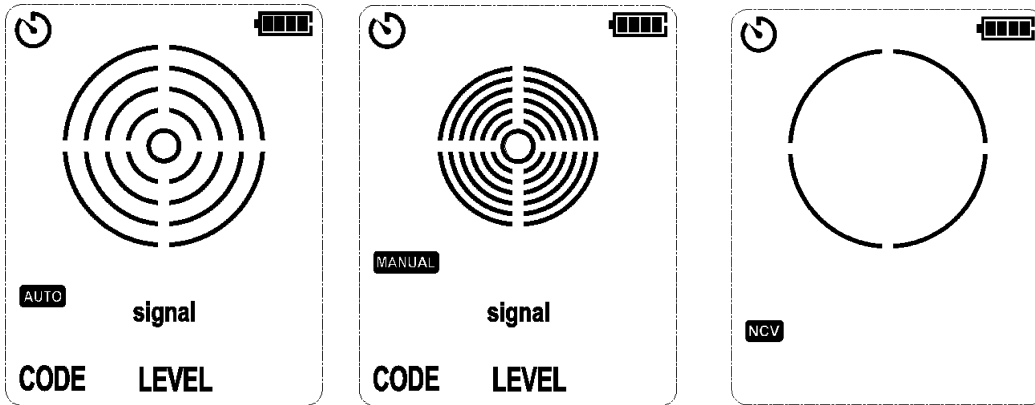

Figure 6.2.3a AUTO

mode

Figure 6.2.3b MANUAL mode

Figure 6.2.3c NCV mode

6.2.4 Buttons Setting

1. The Flashlight button, Backlight/Mute button and NCV button can be used normally in any mode and situation.
2. Short press the flashlight button to turn on/off the flashlight.
3. Short press the backlight/mute button to turn on/off the backlight; long press to turn on/off the mute function.
4. In AUTO scanning mode (in cable tracking mode), the functions of the AUTO/MANUAL and DOWN buttons are enabled.
5. In MANUAL scanning mode (in cable tracking mode), the functions of the AUTO/MANUAL, UP and DOWN buttons are enabled.
6. Long press the power button for >1s to enable the button function.

6.2.5 Descriptions of Keytone

1. When the button function is enabled and the receiver is not muted, the keytone is a high-pitched short sound.
2. When the button is disabled and the receiver is not muted, the keytone is a low-pitched short sound.
3. In mute mode, all buttons and signal sound are muted.

7. Key Applications

Note: Please read the user manual carefully before performing cable tracking.

Perform connection through independent grounding, to avoid counteracting the electromagnetic

field generated around the conductor by the signal produced by the transmitter (the electromagnetic field is detected by the receiver). The clearer the signal, the easier the cable can be tracked. Connect the transmitter with two adjacent conductors of the same circuit (i.e., the live and neutral wires of Romax cable), the signal is transmitted through the first conductor in a direction, and then returns through the second conductor (opposite direction), thus the two opposite-direction electromagnetic fields around adjacent conductors counteract mutually. The electromagnetic fields in opposite directions mutually counteract partially or wholly, which leads to difficulty in tracking cable, or even inability to track. As shown in the figure below:

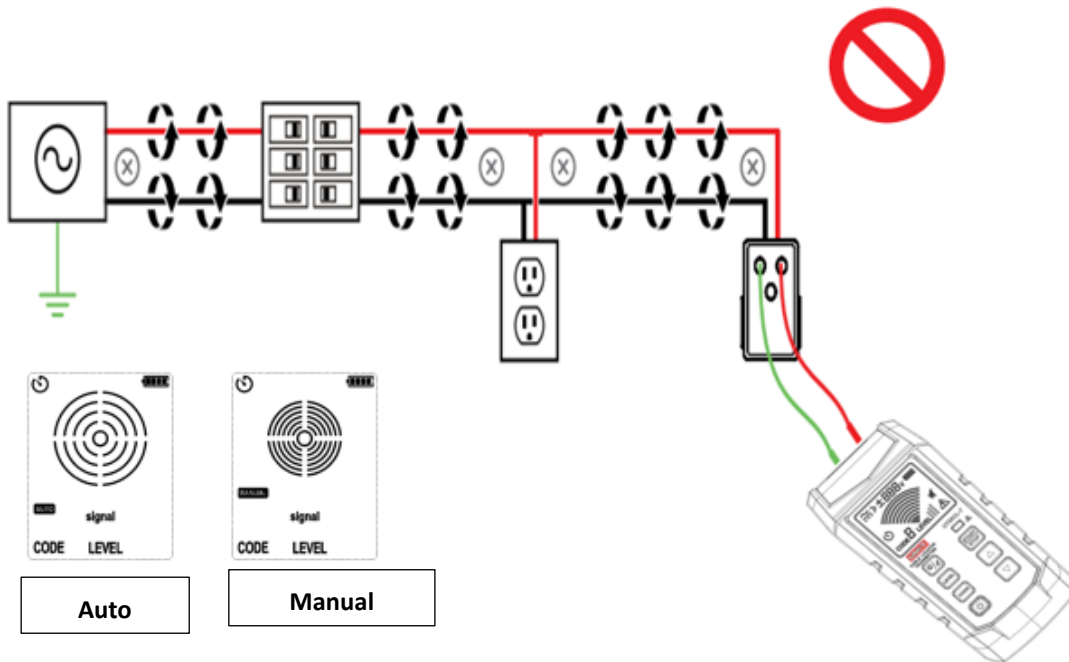

To avoid the counteraction effect, independent grounding shall be employed. The red test lead of the transmitter shall be connected to the live wire of the circuit tracked, and the black to the independent grounding, i.e., water pipe, grounding spike, metal structure of building, or grounding connection of outlet at other circuits. Please note that the independent grounding is not the grounding end of any outlet at the circuit to which the measured conductor belongs. If the live wire is energized and the transmitter is connected to the independent grounding correctly, the LCD of the transmitter will display the AC or DC symbol of corresponding voltage and power supply (For DC, the polarity “+” or “-” will be displayed). For independent grounding, the electromagnetic fields around live wire are not counteracted by the opposite-direction signal of the loop of adjacent conductors (live or neutral wire), and the signal is transmitted through independent grounding, therefore, the intensity of the signal generated is the strongest.

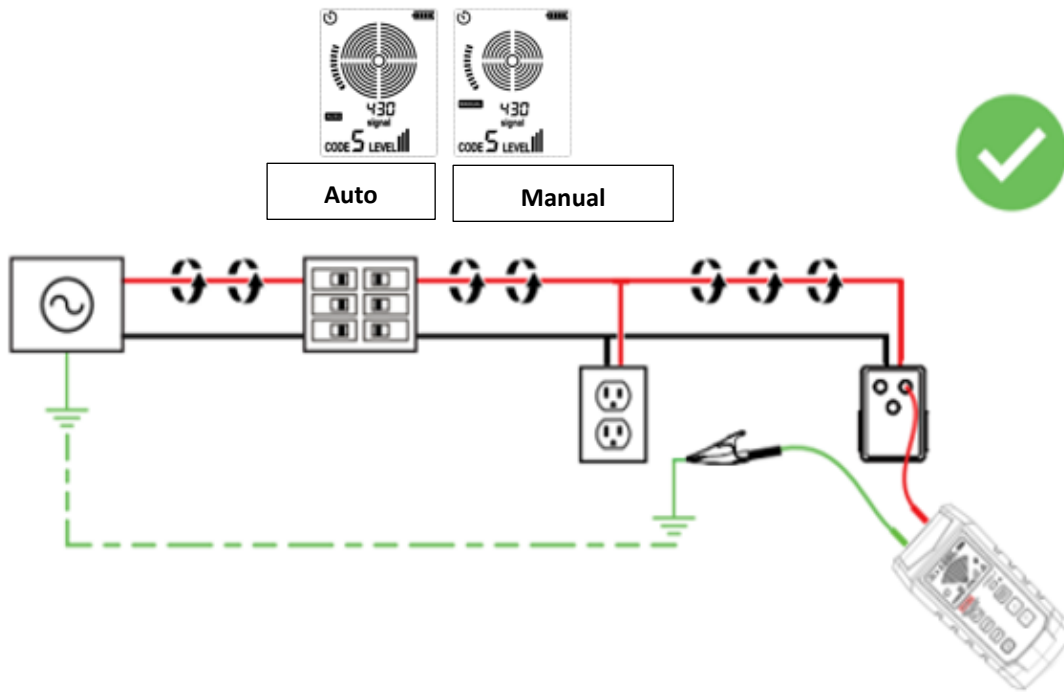

7.1 Track Energized and Deenergized Cables

7.1.1 Connect test leads to the transmitter

1. Connect the black and red test leads to the transmitter (No need to consider the polarity).
2. Connect the outlet convertor to the outlet, and connect the red test lead to the energized live wire (at the load side of the system). Signal is generated only between the power supply and the load side connected with the transmitter. As shown in Figure 7.1.1a.

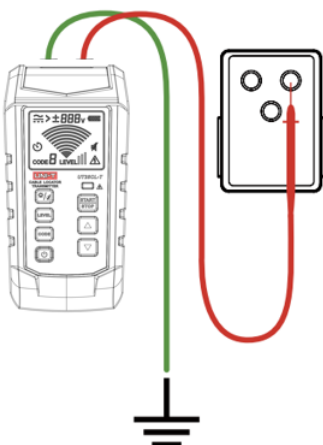

Figure 7.1.1a Correct Connection of Independent Grounding

3. Connect the black test lead to the independent grounding (metal structure of building, metal water pipe, or grounding wire of independent circuit)

Note: If applied to GFCI-protected circuit, this method will trigger GFCI. Please see “Special Applications”. For the tracking method, please see the Section 8.1 “Track the Cable of GFCI-Protected Circuit”

7.1.2 Setting of UT25CL-T transmitter

1. Power on the transmitter.
2. Test and confirm if the connection of test leads is correct. For circuit with voltage over 30 V AC/DC, the warning symbol will light up. As shown in Figure 7.1.2a.

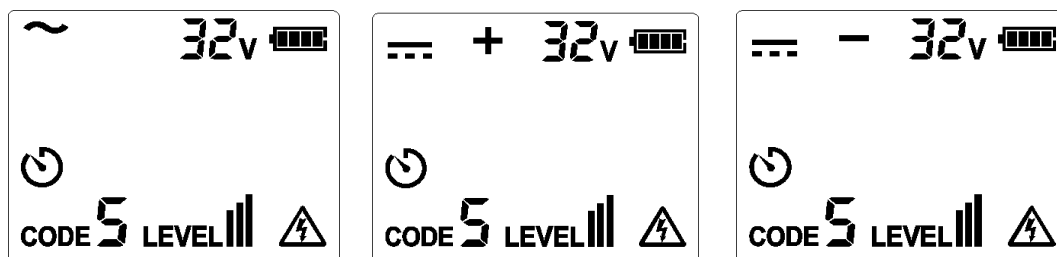

Figure 7.1.2a Voltage over 30V

For deenergized and energized circuit with voltage below 30V AC/DC, the warning symbol will light off.

Note: Please perform connection through the above-mentioned independent grounding.



Figure 7.1.2b Voltage below 30V

3. For most applications, the default transmission strength is III (default code: 5). As shown in Figure 7.1.2c, the level shown on the LCD is III.

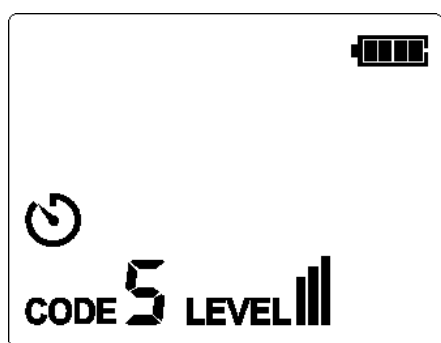

Figure 7.1.2c

Note: To locate the cable more accurately, please set the transmission strength to II or I (As shown in Figures 7.1.2d and 7.1.2e. For specific operating method, please see “6.1.2 LEVEL Setting”), to limit the level of the signal generated by the transmitter. Relatively-low signal level can reduce coupling with adjacent cables and metal objects, which avoids incorrect

reading caused by ghost signal. Relatively-low signal level also helps to prevent the receiver from being oversaturated due to large covering area of strong signal. The signal strength I is only applicable to strict and precise tracking, and is not suitable for wall or cable buried deeply.

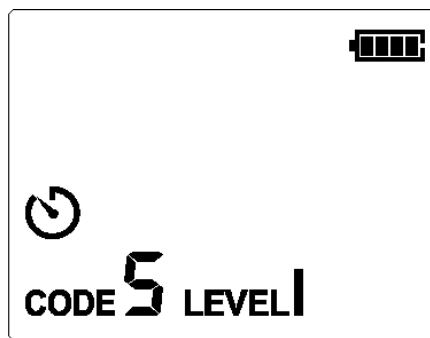
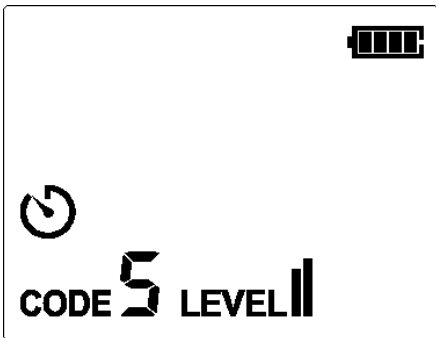

Figure 7.1.2d Transmission Strength II Figure 7.1.2e Transmission Strength I

7.1.3 Use of UT25CL-R receiver (In automatic scanning mode)

The automatic scanning mode is used to detect the conductor at a relatively far distance (between the conductor and the receiver). This mode can automatically adjust the reception sensitivity according to the current signal strength, to prevent the signal from being saturated or too weak. The precision of automatic scanning mode is lower than that of manual mode. This function is applied to detect if tracking signal occurs and to track the path of the conductor rapidly. To locate the cable precisely, please switch to manual mode.

The receiver indicate the signal strength through 3-digit reading, analog indication, and sound.

1. Power on the transmitter and then it enters automatic scanning mode (default mode).
2. Use the sensor to scan the target area, identify signal, and start tracking the cable detected.
3. To obtain a best effect when tracking energized conductor, please align the dot screen printing (on the top of the sensor) to the direction of the conductor, as shown in Figure 7.1.3a. If not aligned properly, signal may not be detected or the code may be wrong. To check the direction of the cable, please rotate the receiver for 90 degrees regularly, as shown in Figures 7.1.3b and 7.1.3c. The signal strength reaches its maximum when the cable is aligned with the dot screen printing. According to the differences of detected signals, the receiver automatically detects if the cable is energized (“⚡”), which will be displayed on the LCD. No need to perform manual setting.

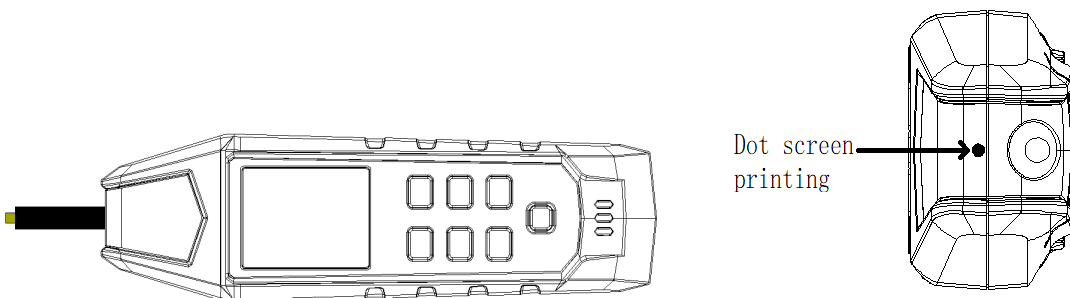

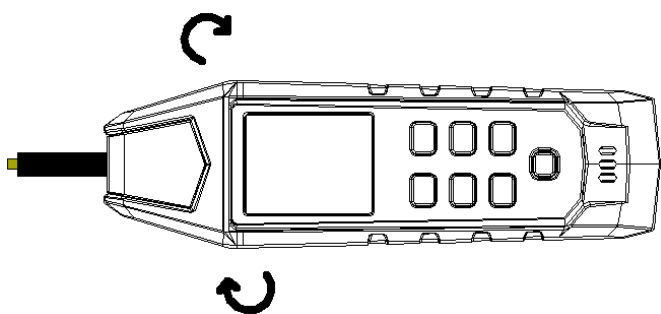

Figure 7.1.3a Align to the sensor slot

Note: To obtain a best effect, please make sure that the distance between the receiver and the transmitter as well as its test lead is 3 ft at least (about 1 m), which reduces signal interference to the greatest extent.

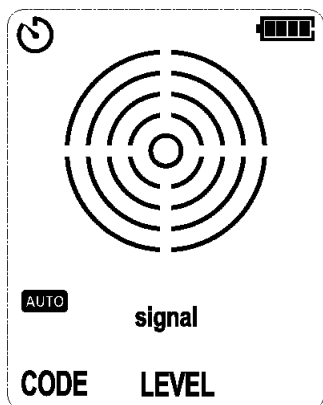

Figure 7.1.3b No Signal Detected

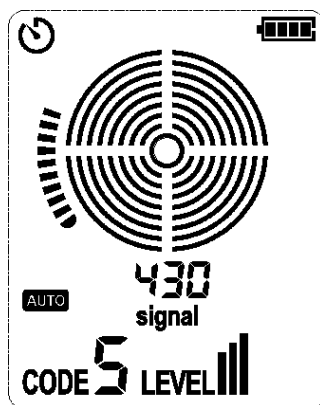

Figure 7.1.3c Signal Detected

7.1.4 Use of UT25CL-R receiver (In manual scanning mode)

Use manual tracking mode to locate cable or fault accurately. The receiver indicates the signal strength through 3-digit reading, analog indication and sound.

1. Short press the “AUTO/MANUAL” (mode) button and then the LCD shows “MANUAL”, as shown in Figure 7.1.4a.

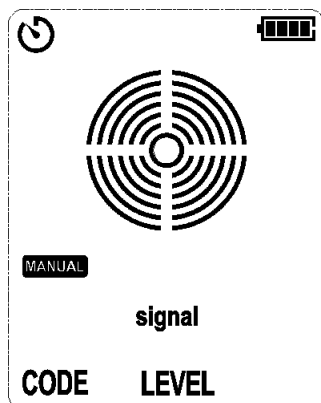

Figure 7.1.4a No Signal Detected

2. Use the sensor to scan the target to identify the maximum signal level. During cabling tracking, please adjust the sensitivity regularly so that the signal strength maintains at a certain range (i.e., 300~600), as shown in Figure 7.1.4b. The sensitivity can be increased or decreased by pressing the UP or DOWN button. If the signal strength is too high, please set the transmission level to II

or I (For specific setting, please see “6.1 UT25CL-T Setting”)

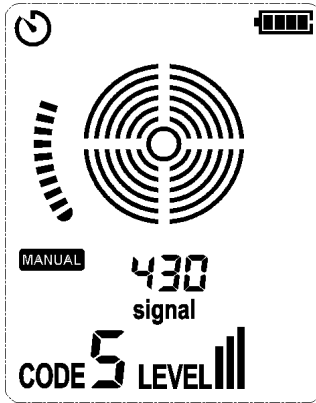

Figure 7.1.4b Signal Detected

- To obtain a best effect when tracking energized conductor, please align the dot screen printing (on the top of the sensor) to the direction of the conductor, as shown in Figures 7.1.4a and 7.1.4b. If not aligned properly, signal may not be detected or the code may be wrong. To check the direction of the cable, please rotate the receiver for 90 degrees regularly. The signal strength reaches its maximum when the cable is aligned with the dot screen printing. According to the differences of detected signals, the receiver automatically detects if the cable is energized (“⚡”), which will be displayed on the LCD. No need to perform manual setting.

7.2 Identify Circuit Breaker and Fuse (Energized and Deenergized)

For identifying circuit breaker, the cable locator generally needs to determine a correct circuit breaker according to the signal strength and the code accuracy.

Note: For locating circuit breaker, connecting to live and neutral wires simply and directly can be chose, since the conductors at the panel of the circuit breaker are independent. If the mutual distances between conductors are several inches at least, there is no risk of signal counteraction. However, if cable tracking is needed beside the identification of circuit breaker, independent grounding shall be used to obtain best effect. Connecting to live and neutral wires simply and directly will not trigger the GFCI-protected circuit. As shown in Figures 7.2a and 7.2b.

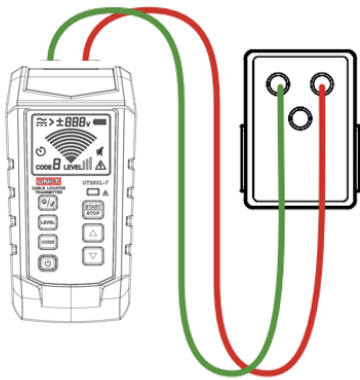

Figure 7.2a Simple Connection

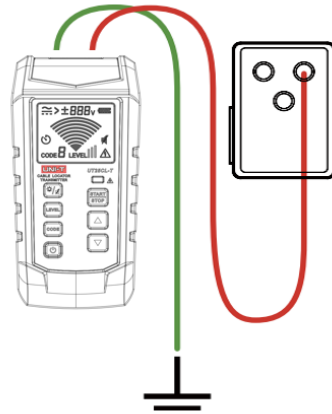

Figure 7.2b Independent Grounding (Preferred choice)

7.2.1 Connect test leads

1. Connect the transmitter through simple connection or independent grounding.
2. Through simple connection: Connect the test lead to live or neutral wire directly. Since signals counteract mutually, cable cannot be tracked when locating circuit breaker.
3. Through independent grounding: Connect the red test lead to the energized live wire at the load side of the system. Signal is generated only between the power supply and the outlet connected with transmitter.
4. Connect the black test lead to independent grounding, i.e., metal structure of building, metal water pipe, or grounding wire of independent circuit.

7.2.2 Use of UT25CL-T transmitter

1. Power on the transmitter.
2. Test and confirm if the connection of test leads is correct. For circuit with voltage over 30 V AC/DC, the warning symbol will light up; for deenergized and energized circuit with voltage below 30V AC/DC, the warning symbol will light off. Note: Please perform connection through the above-mentioned independent grounding.
3. For most applications, the default transmission strength is III (default code: 5). As shown in Figure 7.2.2a, the level shown on the LCD is III.

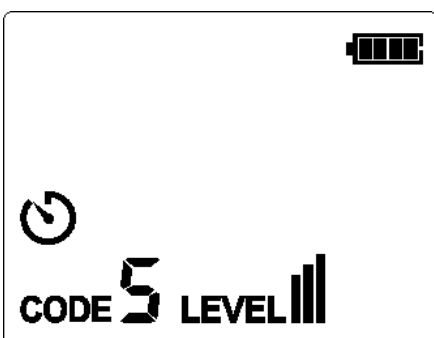

Figure 7.2.2a

Note: To locate the cable more accurately, please set the transmission strength to II, to limit the level of the signal generated by the transmitter. Relatively-low signal level can reduce coupling with adjacent cables and metal objects, which avoids incorrect reading caused by ghost signal. Relatively-low signal level also helps to prevent the receiver from being oversaturated due to large covering area of strong signal.

7.2.3 Use of UT25CL-R receiver

1. Power on the receiver and then short press the AUTO/MANUAL button to switch to manual mode, as shown in Figure 7.2.3a.

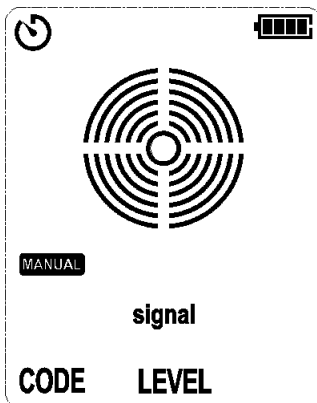

Figure 7.2.3a No Signal Detected

2. Align the dot screen printing (on the top of the receiver) to the circuit breaker, as shown in Figure 7.2.3b.

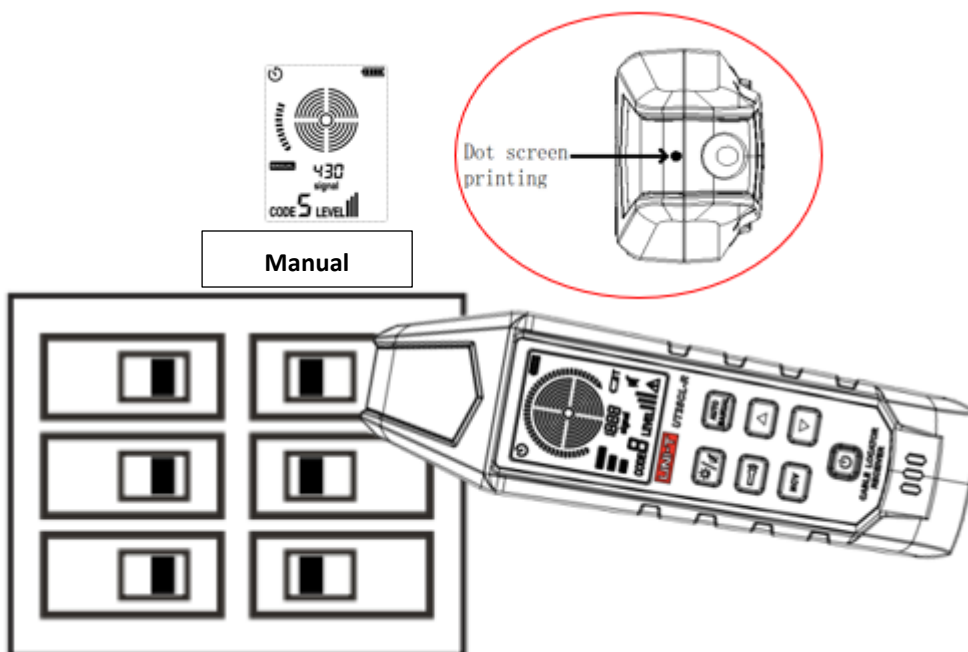

Figure 7.2.3b Align the dot screen printing to the circuit breaker

3. Scan all circuit breakers in random sequence. Scan the circuit breakers multiple times to observe the signal strength displayed on the LCD, until a circuit breaker panel with strongest signal is identified. During scanning, the sensitivity needs to be adjusted repeatedly, to prevent the

accuracy from being affected by signal with over-high strength. As shown in Figure 7.2.3c.



Figure 7.2.3c Signal Detected

Note: Since the designs, heights and internal contact structures of the circuit breakers are different, the accuracy of identifying circuit breaker may be affected. To obtain a reliable result, please open the circuit breaker panel to scan the conductor instead of the circuit breaker. During scanning, if more than one circuit breakers indicated by signal are found, please keep scanning the indicated circuit breakers until only one circuit breaker is identified correctly. According to the differences of detected signals, the receiver automatically detects if the cable is energized (“⚡”), which will be displayed on the LCD. No need to perform manual setting. The reception sensitivity can be adjusted by pressing the UP/DOWN button.

7.3 NCV Mode and Passive Tracking

Without the use of transmitter, the NCV (Non-Contact Voltage) mode can be used to test if cable is energized or to track cable. If the voltage is 80 V~1000 V AC (50~60 Hz), the receiver can detect and track the energized cable, without current flowing through it.

Note: For safety, please use a tester to confirm that the circuit is energized or not before performing circuit operation.

NCV operation: Power on the receiver.

In cable tracking mode, short press the NCV button (In NCV mode, short press the NCV button to switch to AUTO mode under cable tracking mode) to switch to NCV detection function. For passive tracking, the sensor is used to scan the target area to identify the highest signal level. To test if the cable is energized, please make the sensor of the receiver approach the cable, as shown in Figures 7.3.1a and 7.3.1b.

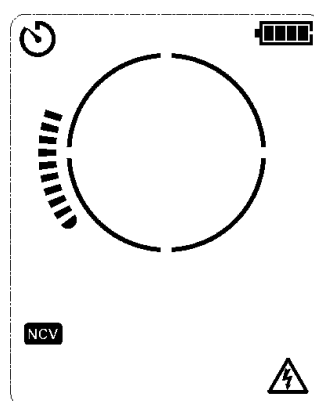
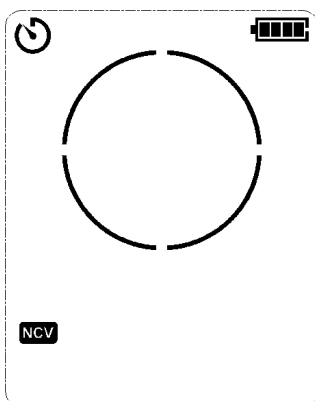

8. Special Applications

8.1 Track the Cable of GFCI-Protected Circuit

When connecting UT25CL-T transmitter to GFCI-protected circuit, if connect the transmitter to the energized GFCI-protected circuit by the use of independent grounding, maybe trigger GFCI protection. For GFCI-protected circuit, please use the methods below: For deenergized GFCI-protected outlet which will not be triggered, please connect the test lead to the contact point of the outlet, in deenergized sensor mode.

Method 1: Bypass GFCI-protected circuit to avoid triggering GFCI (Applicable to energized GFCI-protected outlets only)

1. Remove the protective outlet panel.
2. Use alligator clip to connect the red test lead to the connection screw between the energized live wire and the outlet.
3. Connect the black test lead through independent grounding.
4. Please perform tracking according to the instructions of the sections about automatic and manual scanning modes.

Method 2: To avoid triggering GFCI, independent grounding is not used. (Applicable to GFCI-protected outlet and circuit breaker)

1. Connect the test lead of transmitter to neutral and live wire.
2. Perform tracking in automatic or manual scanning mode.

Note: This method will cause signal coupling and reduce the signal strength. If the signal is too weak or cannot be tracked, please use Method 3.

Method 3: Switch off the circuit power (Applicable to GFCI-protected circuit breaker)

1. Connect the transmitter to the conductor according to the instructions in the section of cable tracking mode.
2. Perform tracking in automatic or manual scanning mode.

8.2 Identify Breakpoints/Opens

Even though the cable is on the wall, ground or ceiling, the breakpoint of the conductor can be identified accurately in precise tracking mode.

1. Make sure the cable is deenergized.
2. Connect the transmitter and perform tracking according to the steps described in the section of automatic or manual scanning mode.
3. To obtain a best result, please use the black test lead to ground all parallel deenergized cables. As long as the metal conductor is connected, the tracking signal generated by the transmitter will be transmitted along the cable. Track the cable to identify the fault until the signal is stopped. To verify the location of the fault, please move the transmitter to the other end of the cable to perform tracking. If the signal is stopped at the same location, then the location of the fault is found.

Alternatively, connect two UT25CL-T transmitters (set different codes for them) to both ends of the cable respectively. If the signal is in the same location, the code is updated to the other receiver after the receiver passes above the breakpoint, then the location of the fault is found. As shown in Figures 8.2.1a and 8.2.1b.

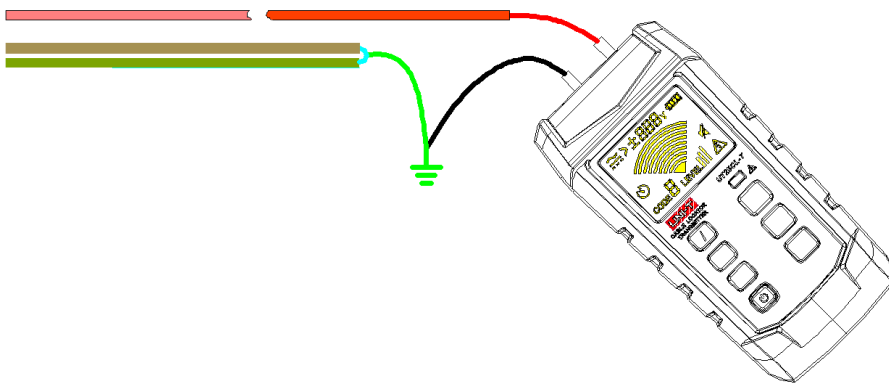

Figure 8.2.1a Locate the breakpoint and the open

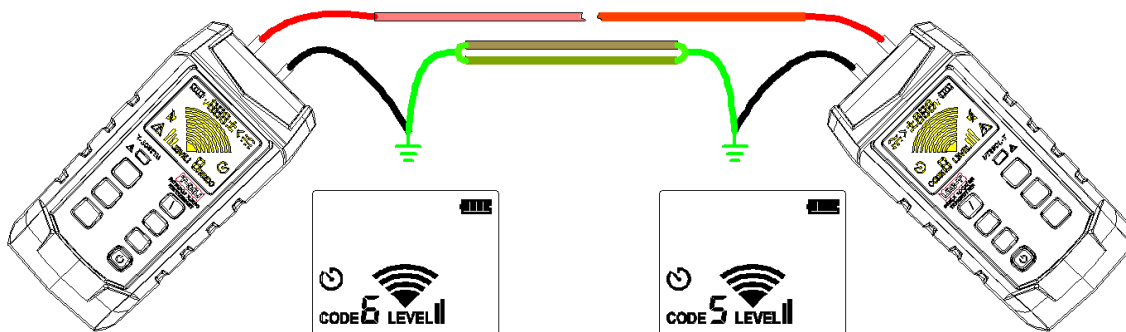

Figure 8.2.1b Locate the breakpoint and the open via multiple transmissions (with the codes set to different values)

Note: If the location of the fault is not found, please decrease the LEVEL value of the transmitter and then proceed as mentioned above. If not found yet after decreasing the LEVEL, then the fault may be a high-resistance breakpoint (Cable is open-circuited partially. According to actual experiences, the breakpoint can be found if the impedance is more than 50 kΩ.). Such breakpoints will impede large current, but the tracking signal can still be transmitted through the breakpoint. Such breakpoints cannot be detected by instrument, unless the cable is open-circuit wholly. To locate the breakpoint and the open via multiple transmissions, please decrease the LEVEL value (i.e., set to level II or I to avoid mutual interference) of the transmitter appropriately according to actual situation.

8.3 Identify Shorts

The shorted cable will trigger the circuit breaker. To correct the fault, please disconnect the cable, and make sure that the conductors at the both ends of the cable are isolated mutually and are isolated with other conductors or loads. **If there are residual charges at the circuit, please disconnect the power before test.**

1. Connect the test lead of the transmitter to the circuit, as shown in Figure 8.3.1a.
2. Power on the transmitter and confirm the LEVEL value is set to III.

3. Set the receiver to automatic or manual scanning mode. Track the cable to identify the fault until the signal is stopped. To verify the location of the fault, please move the transmitter to the other end of the cable to perform tracking. If the signal is stopped at the same location, then the location of the fault is found.

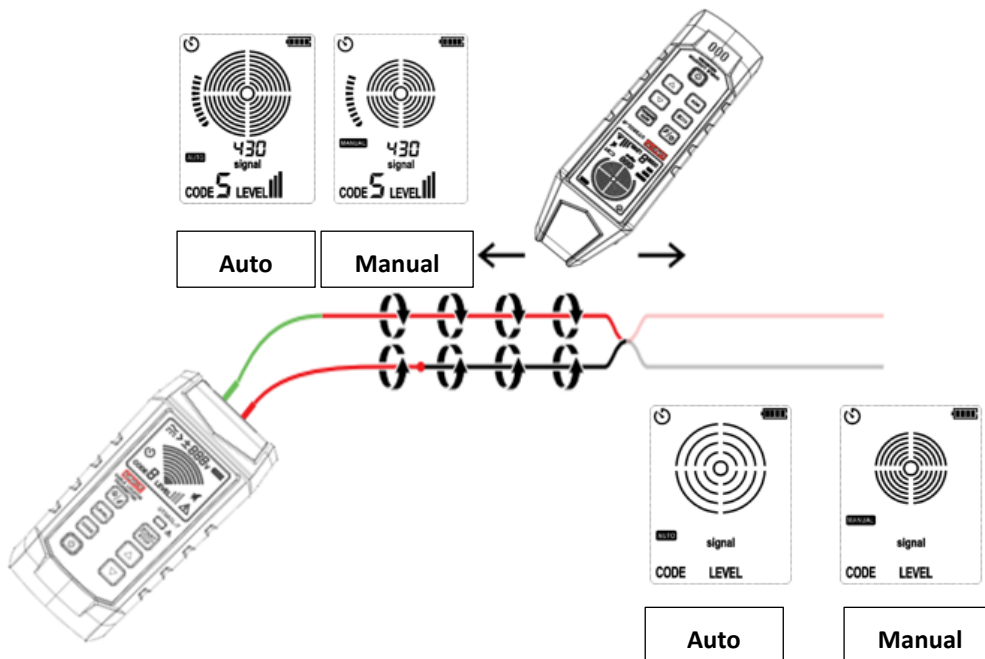

Figure 8.3.1a Identify shorts by tracking cable

Note: This method is affected by the signal counteraction effect. The signal will be relatively weak.

The effects of the winding of cable and permittivity of medium on the locating depth are different. If the location of the fault is not found, please decrease the LEVEL value of the transmitter and then proceed as mentioned above. If not found yet after decreasing the LEVEL, then circuit is not shorted wholly (According to actual experience, the short-circuit point can be found when the impedance is less than 20 Ω).

8.4 Track Cables in Metal Pipe

The receiver cannot penetrate the metal pipe to pick up the signal of the cable. The metal wire groove will shield the tracking signal completely. Note: The receiver can detect the cable in non-metal wire groove. For these applications, please see “7.1 Track Energized and Deenergized Cables” for specific operation.

Track the cable in metal pipe:

1. Track in automatic or manual scanning mode.
2. Open the junction box. Use the sensor of the receiver to detect which cable in the junction box has signal.
3. Move to next junction box according to the circuit. Note: If signal is applied to the wire groove directly, the signal will be sent through all pipe branches, thus the specific path of the wire groove cannot be tracked.

8.5 Track Shielded Cables

If following the standard instructions, the receiver cannot track the signal of shielded cable. To track the shielded cable effectively, please perform according to the following steps.

8.5.1 Ground the far end of shielded cable

1. The default LEVEL is III after the transmitter is powered on.
2. Disconnect the grounding of the near end of shielded cable, and use test lead to connect the shielded layer to the terminal (V+ port) of the transmitter.
3. Connect the second output (COM) of the transmitter to independent grounding.
4. Set the receiver to automatic or manual scanning mode to track the shielded cable.
5. See Figure 8.5.1a for specific application.

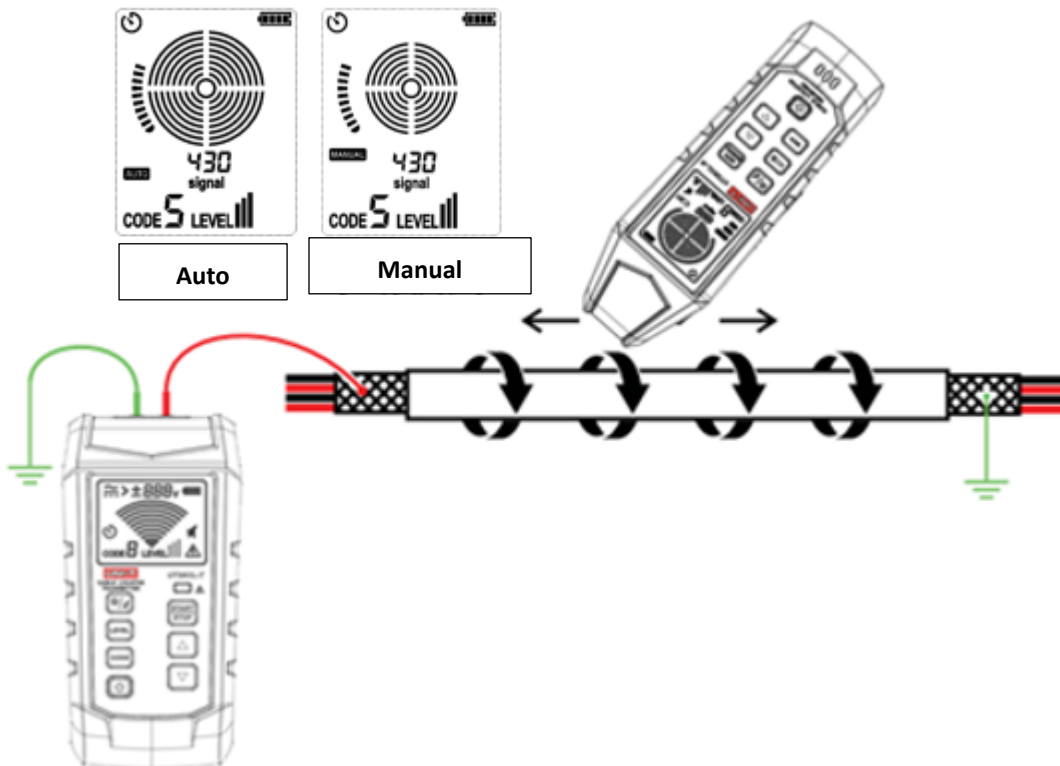

Figure 8.5.1a Track shielded cable (with its far end grounded)

8.5.2 Disconnect the far end of shielded cable from the grounding

1. Set the LEVEL to II when the transmitter is powered on.
2. Disconnect the grounding of the near end of shielded cable, and use the test lead to connect the shielded layer to the terminal (V+ port) of the transmitter.
3. Connect the second output (COM) of the transmitter to independent grounding.
4. Set the receiver to automatic or manual scanning mode to track the shielded cable.
5. See 8.5.2a for specific application.

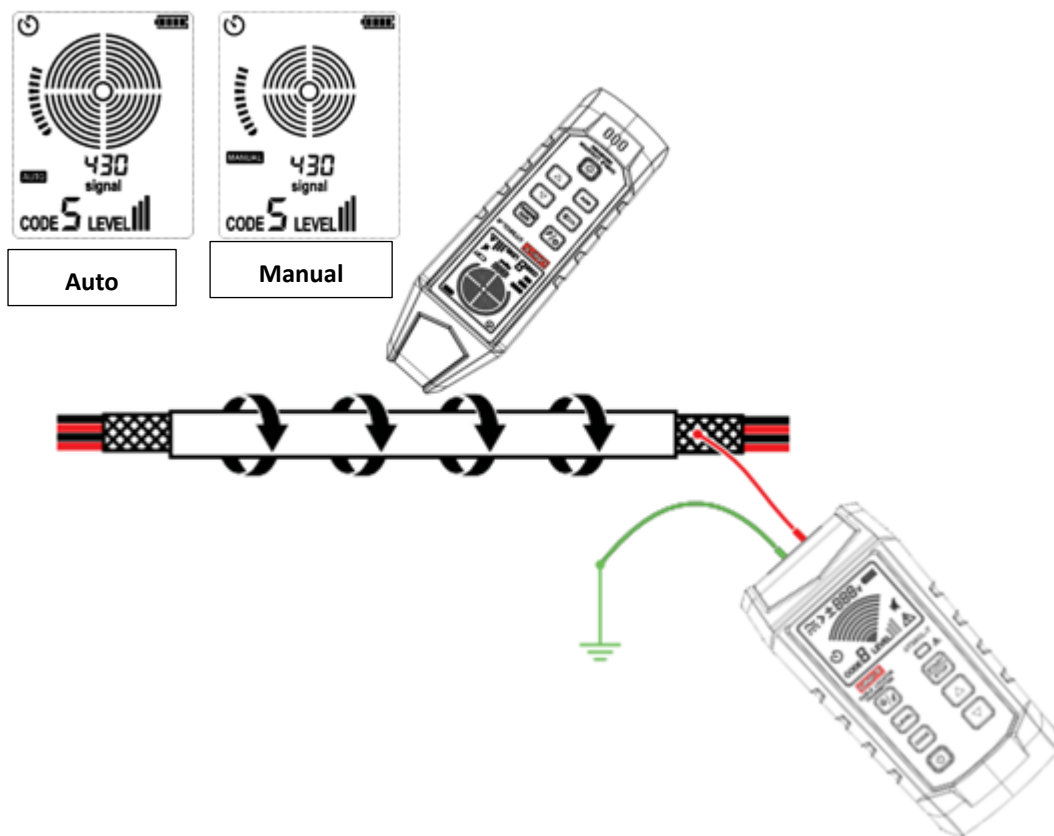

Figure 8.5.2a Track shielded cable (with its far end disconnected from grounding)

8.6 Track Underground Wire

UT25CL can track energized or deenergized cables buried in ground, the tracking method is same as that of locating the cable on wall or ground. Please perform tracking by using independent grounding. The default LEVEL is III after the transmitter is powered on. As shown in Figure 8.6.1a.

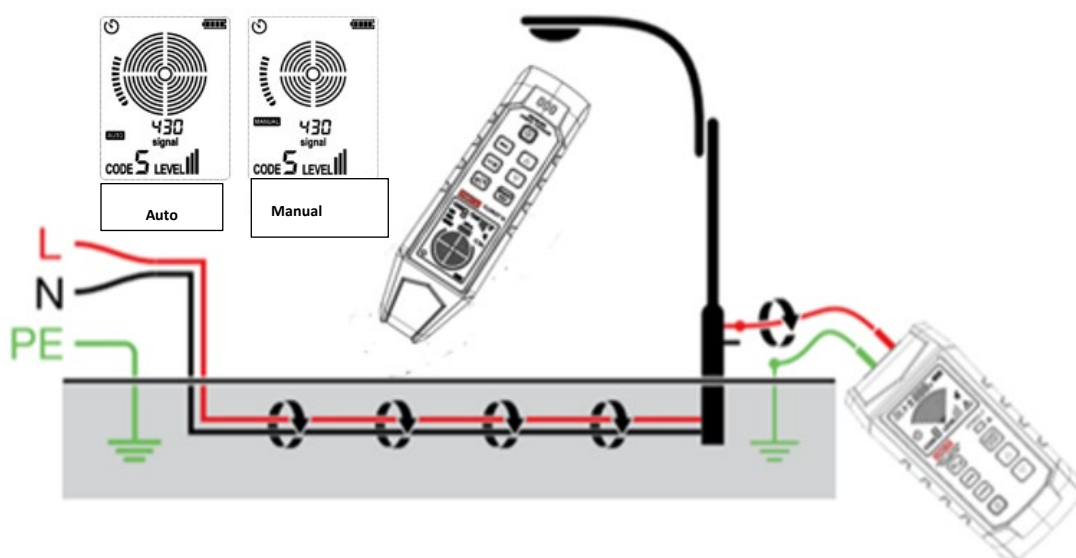

Figure 8.6.1a Track the cable buried in ground

8.7 Track Low-Voltage Wire and Data Cable

UT25CL can track data cable, video cable, and thermostat cable (For information about tracking shielded data cable, please see "8.5 Track Shielded Cable"). Track data cable, video cable, and thermostat cable:

1. Connect the transmitter by using independent grounding (See Section 7.1)
2. Set the receiver to automatic or manual scanning mode to track the cable.

8.8 Identify the Specific Cable in Cable Harness

Identify the specific cable in cable harness.

1. Connect the transmitter. If connected to energized cable, please make sure that the transmitter is connected to the load side.
2. Select cable tracking mode for the receiver.
3. One cable each time (or, use multiple UT25CLT transmitters with different codes, maximum 8 transmitters can work at the same time, and decrease the LEVEL to II or I to reduce crosstalk. Each transmitter can be connected to one cable). Pull away each cable from other cables in the cable harness, and then use the sensor to make contact with these cables. The strongest signal represents the correct cable.
4. Use the UP and DOWN buttons to adjust the receiver sensitivity if needed.
5. See Figure 8.8.1a for specific application.

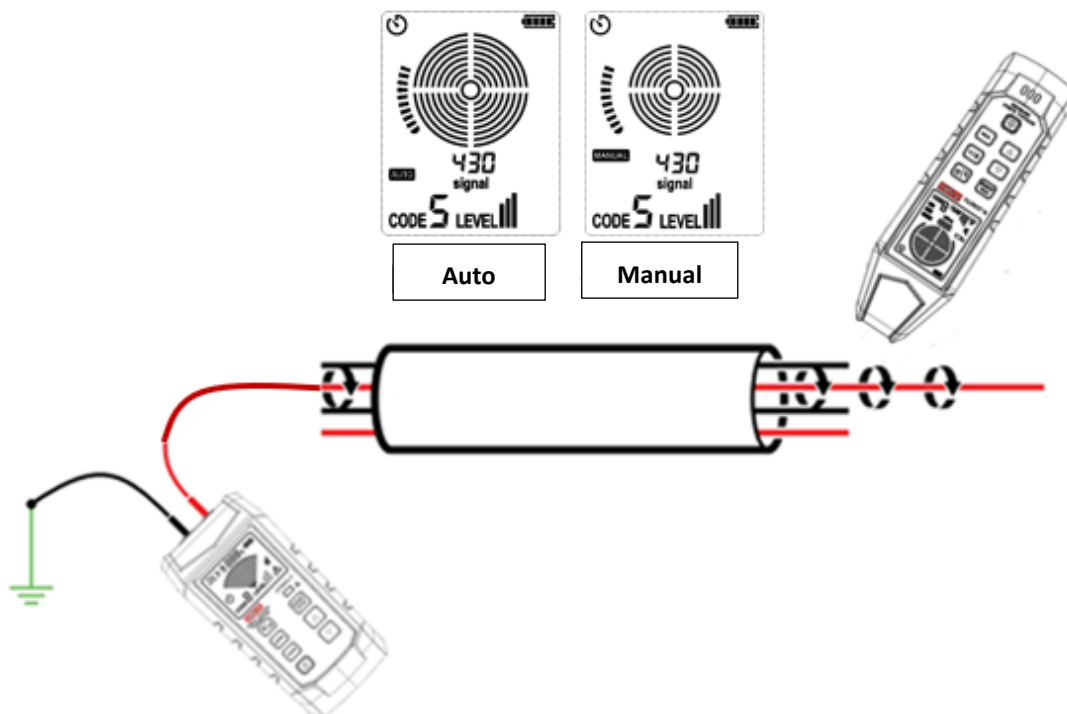

Figure 8.8.1a Identify the specific cable in cable harness

9. External Voltage Measurement and ELV Function (UT25CL-T)

9.1 External Voltage Measurement

1. When the transmitter is in power-on state. Regardless of whether the transmitter transmits signal or not (Some sources will be interfered when transmitting signal. If voltage source is sensitive to the interference, please stop transmitting signal immediately).
2. Connect the red test cable with probe (or the red of polarized plug) to the terminal (V+ port) of the transmitter.
3. Connect the black test cable with probe (or the black of polarized plug) to the terminal (COM port) of the transmitter.
4. When the voltage is 8 V ~ 480 V DC/AC (50/60 Hz). If the measured voltage is DC voltage and the positive pole is connected to V+ port, then the polarity of the port will be displayed (the polarity of V+ port is "+"). As shown in Figure 9.1a.

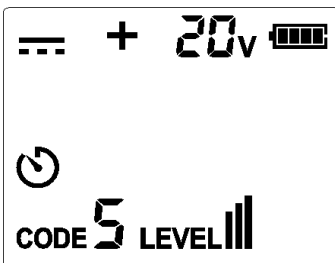

Figure 9.1a DC voltage measurement

5. When the voltage is 8 V ~ 480 V DC/AC (50/60 Hz). If the measured voltage is DC voltage and the positive pole is connected to COM port, then the polarity of the port will be displayed (the polarity of V+ port is "-"). As shown in Figure 9.1b.

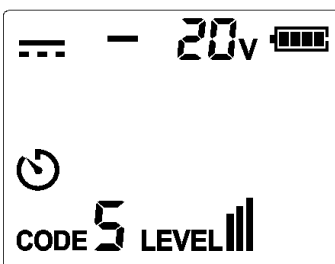

Figure 9.1b DC voltage measurement

6. When the voltage is 8 V ~ 480 V DC/AC (50/60 Hz). If the measured voltage is AC voltage, then the display is as shown in Figure 9.1c.

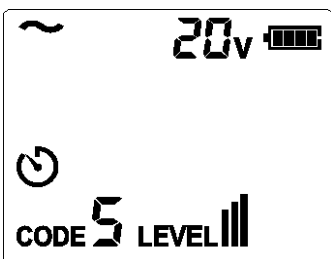

Figure 9.1c AC voltage measurement

7. When the voltage is 8 V ~ 480 V DC/AC (50/60 Hz). If the measured voltage is greater than 30 V, then the display is as shown in Figures 9.1d, 9.1e and 9.1f.

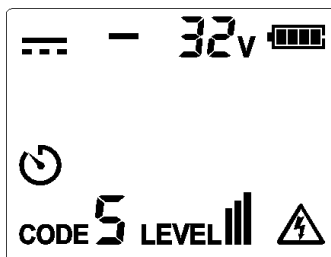
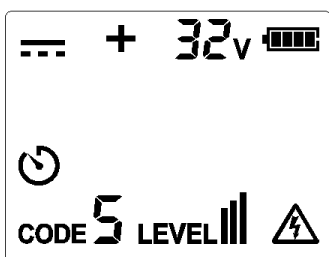

Figure 9.1d DC voltage (>30V) measurement

Figure 9.1e DC voltage (<-30V) measurement

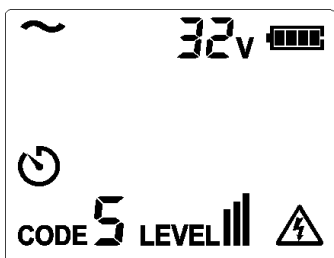

Figure 9.1f AC voltage (>30V) measurement

8. When the voltage is 8 V ~ 480 V DC/AC (50/60 Hz). If the measured voltage is greater than 480 V, then display is as shown in Figures 9.1g, 9.1h and 9.1i.

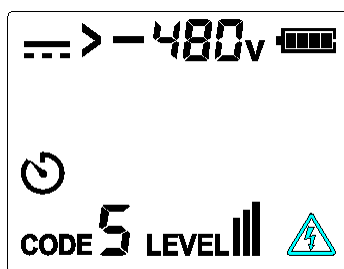
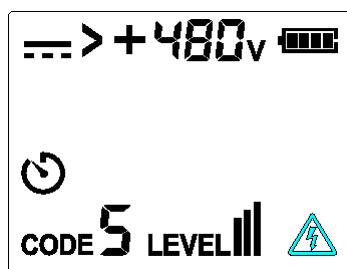

Figure 9.1g DC voltage (>480V) measurement

Figure 9.1h DC voltage (<-480V) measurement

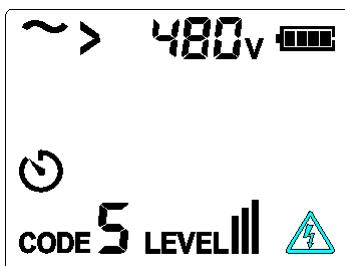

Figure 9.1i AC voltage (>480V) measurement

9.2 ELV Function

If voltage (>25 V) is applied to the port when the transmitter is in power-off state, the ELV indicator light will be lit up, and the brightness will increase as the voltage rises (Do not exceed 480V DC or AC 50/60HZ).

10. Technical Specifications

10.1 Transmitter Specifications

Characteristics	UT25CL-T
Working frequency	33kHz
Identification range of external voltage	8~480V
Identification frequency of external voltage	DC/AC: 50-60Hz
Measurement accuracy of external voltage	2.5%±3deg
Strength of external overvoltage	480V DC/AC
overvoltage rating	CAT III 480V
Pollution degree	2
Display	Segmented LCD (TN translucent)
Battery	6 × 1.5V AA (LR06)
Power consumption	165mA(including backlight, output short circuit, III, CODE5)
Fuse	F0.6A 600V
Operating temperature	0 ~40°C; Max. 80%RH (Non-condensing)
Storage temperature	-20~60°C; Max. 80%RH (Non-condensing)
Operating altitude	≤2000m
External dimensions	189*96*48mm
Drop proof	1 m
Button life	10000 times
Weight (excluding batteries)	About 389g
Weight (including batteries)	About 528g
Backlight	Supported (white)
CODE (Code value)	0, 1, 2, 3, 4, 5, 6 and 7. Default code: 5
Level of signal strength	1, 2 and 3 Default level: 3
Single pole testing	Supported (Support testing in energized condition; Maximum 480V)
Dual pole testing	Supported (Support testing in energized condition; Maximum 480V)
ELV indicator light	1. Without batteries: If external voltage applied is >25V, the ELV LED emits weak light and its brightness increases as voltage rises (light up constantly), otherwise, the ELV LED emits weak light

	<p>or lights off.</p> <p>2. UT25CL-T is in power-on state with batteries installed: the ELV LED lights off</p> <p>3. UT25CL-T is in power-off state with batteries installed: If external voltage applied is >25V, the ELV LED emits weak light and its brightness increases as voltage rises (light up constantly), otherwise, the ELV LED emits weak light or lights off.</p>
Certification	<p>CE Certified</p> <p>EMC: EN IEC 61326-1</p> <p>LVD: EN 61010-1</p> <p>EN IEC 61010-2-033</p>
	<p>Rohs</p>

10.2 Receiver Specifications

Characteristics	UT25CL-R
Working frequency	33kHz
Locating depth	Related to the medium and the method used
Tracking mode for single pole	About 0~2.5 m (Use separate loop wire for 2.5 m)
Tracking mode for dual poles	About 0~0.5 m
Grid voltage identification	About 0~0.4 m
NCV	Voltage identification range: 80~1000V, 50Hz/60Hz (Approach the measured cable)
Display	Segmented LCD (TN translucent)
Battery	6 × 1.5V AAA (LR03)
Power consumption	About 30mA (Excluding backlight and flashlight)
	About 65mA (Excluding backlight)
	Maximum 95mA (including backlight)
Operating temperature	0~40°C; Max. 80%RH (Non-condensing)
Storage temperature	-20~60°C; Max. 80%RH (Non-condensing)
Operating altitude	≤2000m
External dimensions	226*68*38mm
Button life	10000 times
Weight (excluding batteries)	About 287g
Weight (including batteries)	About 354g
Indication for running out of power (For transmitter)	Supported
Backlight	Supported
Flashlight	Supported
CODE (code value)	0, 1, 2, 3, 4, 5, 6 and 7
Levels of signal strength of	Level 1, Level 2, and Level 3

transmitter	
Reception sensitivity (Manual adjustment)	Including 9 levels
Index range of signal strength	0~999
Analog bar range of signal strength	0~43
Receive multiple transmission signals	Supported (A receiver can receive signals generated by maximum 8 transmitters at the same time)
Certification	CE Certified EMC: EN IEC 61326-1 LVD: EN 61010-1 EN IEC 61010-2-033
	RoHS
Indoor use	✓

11. Maintenance

11.1 Battery Replacement (UT25CL-T)

The battery compartment of the transmitter is specially designed to facilitate battery replacement. The batteries are fixed by two screws, which prevents damage to the batteries in case the transmitter falls down. 6 pieces of AA alkaline batteries can be used.

Note: Batteries are not preinstalled.

1. Make sure that the transmitter is powered off and that all test leads are removed and disconnected from all circuits.
2. Use screwdriver to loosen the screws at the battery compartment.
3. Remove the battery cover.
4. Install batteries.
5. Install the battery cover and fasten it with the screws.

11.2 Battery Type and Threshold (Transmitter)

Battery type: AA LR06 alkaline battery

Battery state: 6 pieces of batteries of the same type (Connected in series)

Battery threshold:

The battery symbol displays different levels of battery power (including 4 levels):

>8V to 9V: Level 4 “” is displayed.

>7.2V to ≤8V: Level 3 “” is displayed.

>6.6V to ≤7.2V: Level 2 “” is displayed.

>6.2V to ≤6.6V: Level 1 “” is displayed.

≤6.2V: The batteries run out of power. The symbol “” flashes three times (flashing frequency: 2Hz) and the transmitter powers off. (There is an accuracy error of about 5% with the voltage of the critical point between levels)

11.3 Fuse Replacement (UT25CL-T)

Dismantle the battery compartment (See “11.1 Battery Replacement”), loosen the batteries at the rear cover (as shown in Figure 11.3), remove the rear cover, use a tool to take off the fuse, and install a new same-type fuse.

Note:

1. Make sure that the transmitter is powered off and that all test leads are removed and disconnected from all circuits.
2. Use screwdriver to loosen the screws at the battery compartment.
3. Remove the battery cover and take out the batteries.
4. Loosen the screws at the rear cover.
5. Remove the rear cover and take out the fuse.
6. Install new fuse.
7. Install the rear cover and fasten it with the screws.
8. Install battery cover and fasten it with the screws.

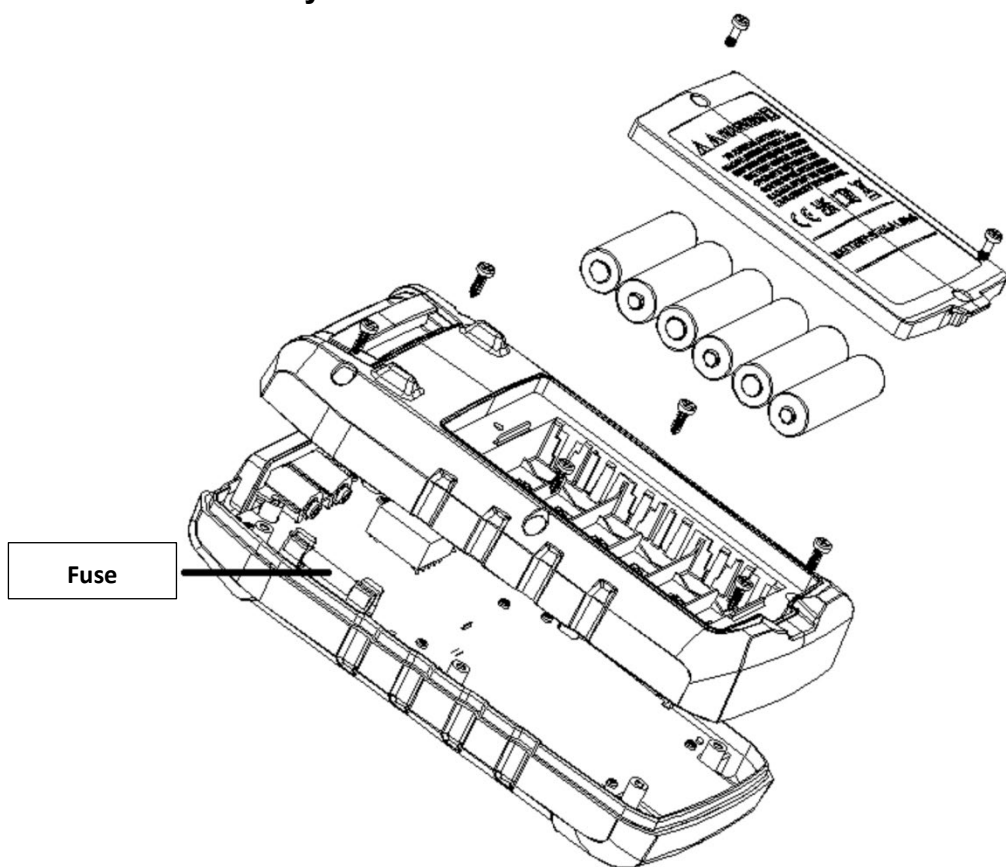

Figure 11.3 Fuse Replacement

11.4 Battery Replacement (UT25CL-R)

The battery compartment of the receiver is specially designed to facilitate battery replacement. The batteries are fixed by a screw, which prevents damage to the batteries in case the receiver falls down. 6 pieces of AAA alkaline batteries can be used.

Note: Batteries are not preinstalled.

1. Make sure that the receiver is powered off and disconnected from all circuits.
2. Use screwdriver to loosen the screw at the battery compartment.
3. Remove the battery cover.
4. Install batteries.
5. Install the battery cover and fasten it with the screw.

11.5 Battery Type and Threshold (Receiver)

Battery type: AAA LR03 alkaline battery

Battery state: 6 pieces of batteries of the same type (Connected in series)

Battery threshold:

The battery symbol displays different levels of battery power (including 4 levels):

>8V to 9V: Level 4 “” is displayed.

>7.2V to ≤8V: Level 3 “” is displayed.

>6.6V to ≤7.2V: Level 2 “” is displayed.

>6.2V to ≤6.6V: Level 1 “” is displayed.

≤6.2V: The batteries run out of power. The symbol “” flashes three times (flashing frequency: 2Hz) and the transmitter powers off. (There is an accuracy error of about 5% with the voltage of the critical point between levels)

WARNING: Cancer and reproductive harm-See www.P65Warnings.ca.gov for more information