

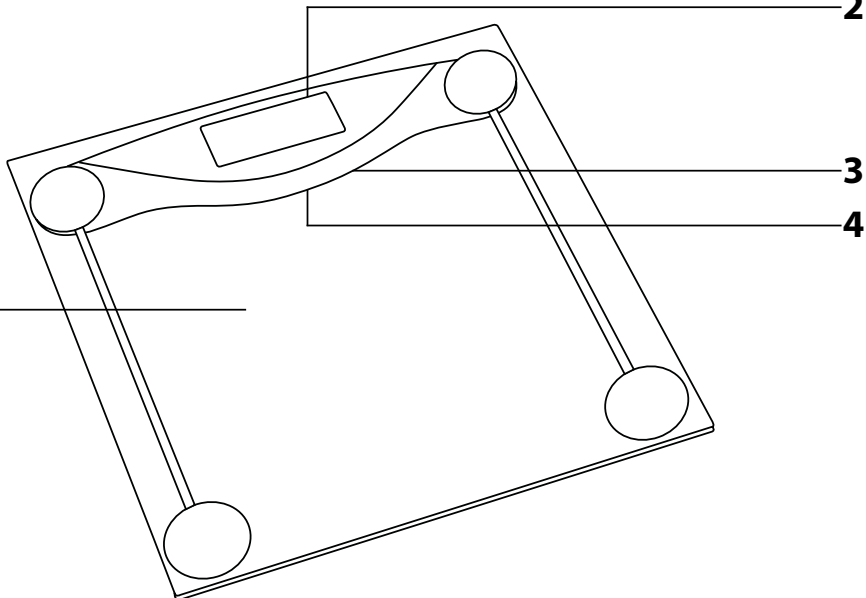
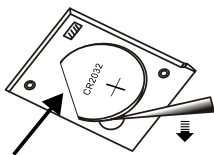
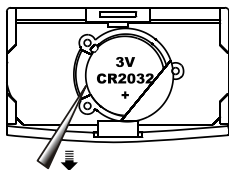
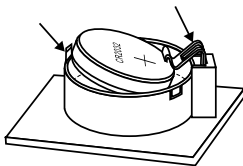
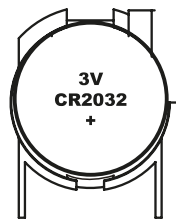
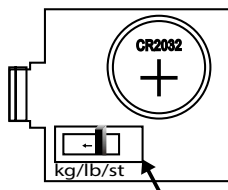
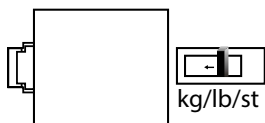
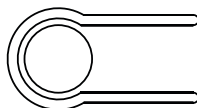

EN ■ Personal Scale

A**1****1****2****3****1****2****3**

SAFETY INSTRUCTIONS AND IMPORTANT NOTES

- Prior to using this appliance, please read the user's manual thoroughly, even in cases, when one has already familiarised themselves with previous use of similar types of appliances. Only use the appliance in the manner described in this user's manual. Keep this user's manual in a safe place where it can be easily retrieved for future use.
- We recommend saving the original cardboard box, packaging material, purchase receipt and responsibility statement of the vendor or warranty card for at least the duration of the legal liability for unsatisfactory performance or quality. In the event of transportation, we recommend that you pack the appliance in the original box from the manufacturer.
- The appliance is designed for use at home, in offices and similar types of areas. Do not use it for commercial, medical or other purposes.
- This appliance may be used by children and persons with reduced physical, sensory or mental abilities or with insufficient experience and knowledge if they are properly supervised.
- Children must be supervised to ensure that they do not play with the appliance.
- Do not use the appliance outdoors, do not locate it on unstable surfaces or in the vicinity of an open fire or other sources of heat.
- Do not expose the appliance to direct sunlight or high humidity and do not use it in an excessively dusty environment.
- Make sure that the appliance is located on an even, smooth, hard and stable surface. This applies especially when using the appliance. Otherwise, this could result in inaccurate measurement.
- Prior to stepping on the weighing platform, check that it is not damp and that your feet are not wet. Otherwise, this presents a slipping hazard.
- Do not jump on the appliance and do not exceed its maximum weighing capacity. Otherwise, it could be damaged.
- Do not use the appliance as a place for placing items. Store it in a horizontal position and ensure that no items are placed on it.
- Despite the risk of the lithium battery leaking being very low, remove the battery from the appliance when you decide that you will not be using it for an extended period of time. If the battery were to leak into the inner area of the appliance, this could result in its damage.
- Do not use rechargeable batteries to power this appliance.
- Keep the batteries out of children's reach as they may present a hazard to a child. In the event that a child swallows a battery, immediately seek medical help.
- Keep the appliance clean. When cleaning it, follow the instructions in chapter Cleaning and maintenance. Do not submerge the appliance under water or any other liquid and do not rinse it under running water.
- Do not repair the appliance yourself or make any adjustments to it. Have all repairs performed at an authorised service centre. By tampering with the appliance, you risk voiding your legal rights arising from unsatisfactory performance or quality warranty.

DESCRIPTION OF THE SCALE

A1 Weighing platform

from 5 mm thick hardened safety glass

A2 LCD display

A3 Battery compartment (not shown)

found on the underside of the scale.

A4 Weight unit selection switch (not shown)

is located on the underside of the scale.

POWER SOURCE

- This scale comes with one CR 2032 lithium battery (1× 3 V). The battery is inserted in the battery compartment **A3**. Before first use, remove the insulation strip from compartment **A3**. The strip is there to prevent the battery from discharging before the appliance reaches the final customer.
- Replace the battery when "Lo" (weak battery) appears on the display **A2** or when the display **A2** does not light up when the weighing platform **A1** is stepped on. To replace the battery, remove the battery compartment cover **A3**. Take out the flat battery and insert a new battery of the same type in its place. Ensure that correct polarity is maintained and that the battery properly fits into place. Close the cover.
- The battery insertion method into the battery compartment **A3** differs depending on the type of scale. The options for battery removal are listed below:
 - To remove the battery, use an implement with a blunt tip, see figure B1.
 - The battery compartment **A3** is fitted with a band that serves to release the battery to make its removal easier. Pull on this band to release the battery and enable the battery to be removed, see figure B2.
 - Gently push the battery downwards. This will release it from the battery compartment **A3** and subsequently it can be easily removed, see figure B3.



Attention:

Only use CR 2032 type batteries to power this appliance. Do not use rechargeable batteries.

USING THE SCALE

- Place the scale on an even, smooth, hard and stable surface. Do not place it on a carpet or any other soft surface, otherwise the weighing result may be inaccurate.
- Step on the weighing platform **A1** with both feet and stand still. The scale is equipped with an "Auto-On" function, which automatically starts the weighing process immediately after the scale is stepped on. Within a few moments, your weight will stabilise on the display **A2**. The measured weight will be shown on the display **A2** for 10 seconds.
- When weighing yourself, stand still and do not lean. For weighing results to be comparable, it is necessary to weigh yourself at the same time of day, ideally in the morning. The weighing results are influenced by the weight of the clothing that you are wearing as well as the food and drink that you consume before weighing yourself.
- The scale turns itself off automatically when you step off it, or after approximately 10 seconds of inactivity, where the measured weight is displayed on the display **A2**.
- If "C" appears on the display **A2** when you step off the scale, it means that a weighing error occurred. Weigh yourself again.

WEIGHT UNIT SELECTION

- Switch **A4** enables selecting either metric (kg) or imperial (lb, st) measuring units.
- This switch **A4** may be located inside or next to the battery compartment **A3**. Its design and location depends on the type of scale. Unit conversion is performed by:
 - sliding the switch to the required position, see figure C1 and C2,
 - pressing the switch, see figure C3.



Note:

1 kg (kilogram) = 2.2 lb (pounds)

1 lb (pound) = 0.454 kg (kilograms)

1 st (stone) = 14 lb (pounds) = 6.35 kg (kilograms)

WEIGHING CAPACITY AND PRECISION

- The maximum weighing capacity is 150 kg / 330 lb. In the event that the maximum weighing capacity is exceeded, "Err" will appear on the display **A2**. To prevent damaging the scale, it is necessary to step off the weighing platform **A1**.
- The weighing precision of ± 100 g / ± 0.2 lb may not be guaranteed for items weighing less than 2 kg / 4.4 lb.

CLEANING AND MAINTENANCE

- To clean the scale, use a lightly dampened cloth. Then wipe everything so that it is thoroughly dry. Make sure that when cleaning, no water enters into the battery compartment **A3**.
- When cleaning, do not use steel wool, cleaning products with an abrasive effect, solvents, etc. Otherwise, the cleaned surface may be damaged.
- Do not submerge the scale under water or any other liquid and do not rinse it under running water.

TECHNICAL SPECIFICATIONS

Power supply	1 × 3V CR 2032 type battery
Weighing capacity	150 kg / 330 lb
Weighing precision	100 g / 0.2 lb
Weight unit selection	kg / lb / st

We reserve the right to change text and technical specifications.

INSTRUCTIONS AND INFORMATION REGARDING THE DISPOSAL OF USED PACKAGING MATERIALS

Dispose of used packaging material at a site designated for waste in your municipality.

DISPOSAL OF USED BATTERIES



Batteries contain environmentally damaging compounds and, therefore, do not belong in standard communal waste. Hand over used batteries for proper disposal at locations intended for their collection.

DISPOSAL OF USED ELECTRICAL AND ELECTRONIC EQUIPMENT



This symbol on products or original documents means that used electric or electronic products must not be added to ordinary municipal waste. For proper disposal, renewal and recycling hand over these appliances to determined collection points. Alternatively, in some European Union states or other European countries you may return your appliances to the local retailer when

buying an equivalent new appliance.

Correct disposal of this product helps save valuable natural resources and prevents potential negative effects on the environment and human health, which could result from improper waste disposal. Ask your local authorities or collection facility for more details.

In accordance with national regulations penalties may be imposed for the incorrect disposal of this type of waste.

For business entities in European Union states

If you want to dispose of electric or electronic appliances, ask your retailer or supplier for the necessary information.

Disposal in other countries outside the European Union

This symbol is valid in the European Union. If you wish to dispose of this product, request the necessary information about the correct disposal method from the local council or from your retailer.



This product meets all the basic requirements of EU directives related to it.